

ASSEMBLY INSTRUCTIONS & PARTS MANUAL

Regal Shelving System Model Series: RGL-1836S & RGL-1836A



RETAIN INSTRUCTIONS FOR FUTURE REFERENCE



Starter Unit



Add-On Unit

GENERAL SAFETY INFORMATION

Some parts may have sharp edges. CARE must be taken when handling various pieces to avoid injury. For safety, wear a pair of work gloves when assembling or performing any maintenance on the units.

LIMITED WARRANTY

Tennsco warrants goods purchased hereunder to be free of defects in materials and workmanship for a period of one (1) year from the date of shipment, hereunder. This warranty shall not apply in the event goods are damaged as a result of misuse, abuse, neglect, accident, improper application, modification or repair by persons not authorized by Seller, where goods are damaged during shipment, or where the date stamps on the goods have been defaced, modified or removed. UNLESS CONSIDERED UNENFORCEABLE OR UNLAWFUL UNDER APPLICABLE LAW:

- a. ALL IMPLIED WARRANTIES, INCLUDING BUT NOT LIMITED TO WARRANTIES OR MERCHANTABILITY AND FITNESS FOR A PARTICULAR PURPOSE ARE HEREBY EXCLUDED:
- b. BUYERS REMEDY, IF ANY, FOR ANY DEFECTIVE GOODS SHALL BE LIMITED TO A REFUND BY SELLER OR REPLACEMENT OF THE GOODS AT SELLER'S OPTION, AND SHALL IN NO EVENT INCLUDE DAMAGES OF ANY KIND, WHETHER INCIDENTAL, CONSEQUENTIAL OR OTHERWISE.

NO GOODS ACCEPTED FOR RETURN WITHOUT PRIOR APPROVAL. Seller shall have the right to inspect any goods claimed to be defective at Buyers place of business or require Buyer to return the goods to Seller for inspection on Seller's premises. Transportation charges covering returned goods will be borne by Seller only if such goods are proven to be defective, are covered by this warranty and are returned within the warranty period stated above.



PROUDLY MADE IN THE U.S.A.

Tennsco LLC., Dickson, TN 37056-1888 • (866) 446-8686

ASSEMBLY OF REGAL SHELVING UNIT

Two people are recommended for assembly. Approximate assembly time: 30-40 minutes.

Tool Required: Rubber Mallet

The reference numbers used throughout this sheet refer to the illustration on the back cover.

This is to help you to identify the various parts as they are mentioned.

1. Determine whether you will be assembling a single unit, or multiple units joined together. For a single unit, use two "L" uprights (Ref. No. 1). For multiple units, use one "L" upright and one "T" upright (Ref. No. 2).

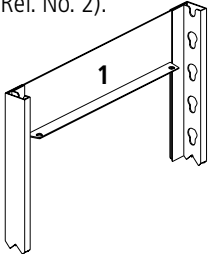

Open "L" Upright

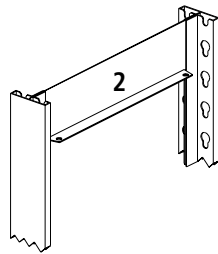

Open "T" Upright

2. Examine the slots on the two uprights you have selected. When an upright is standing up on end, the narrow part of the keyhole slots should be toward the floor, while the wide part should be toward the top.

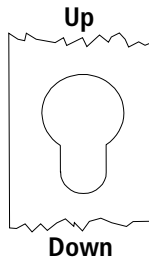

3. After determining which end of the upright is the bottom, attach a plastic foot (Ref. No. 5 or 6) to the bottom of each upright by pressing it into place. Note the differences at right between a foot for an "L" upright and a foot for a "T" upright.

"L" Upright

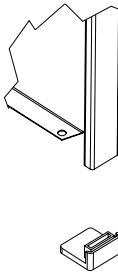

"T" Upright

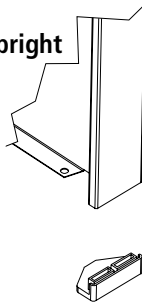

4. Lean one "L" upright against a wall, and temporarily place one shelf support (Ref. No. 3) at approximately eye level to properly space the uprights. Make sure both rivets on the shelf support are fully inserted into the keyhole slots, and are firmly seated at the bottom of the keyhole as shown in step 5.

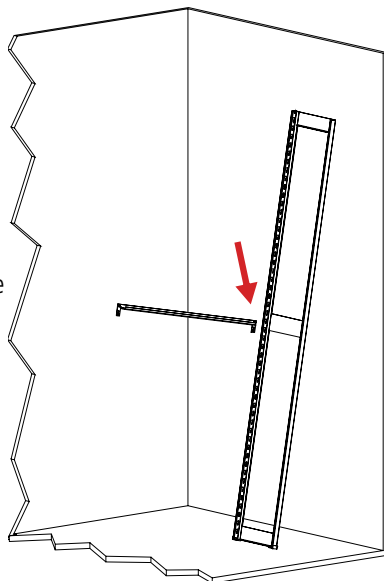

5. To firmly seat shelf supports and backstops, make sure both rivets are fully inserted in the keyhole slots, and firmly seated in the bottom of the slot. A rubber mallet can be helpful in accomplishing this.

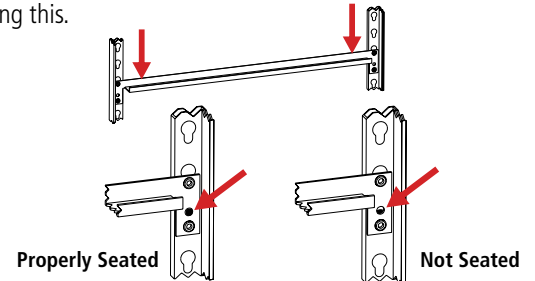

NOTE: Supports are not fully seated unless you can see an open space through the hole in the shelf support as shown above.

6. Hold a second "L" upright (or a "T" upright if you are assembling multiple units) approximately 36" away. Pull the first upright away from the wall using the shelf support you attached in step 4, and insert the other end of the shelf support into the second upright.

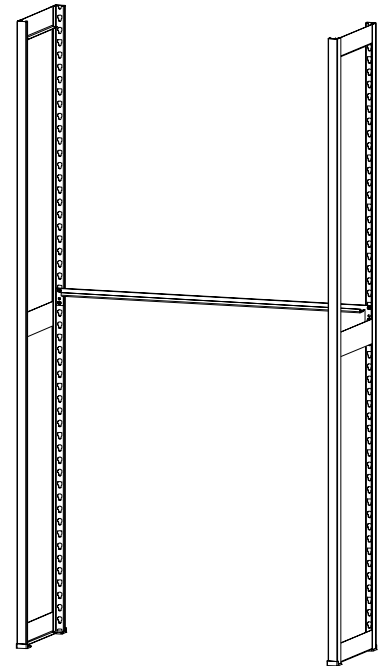

NOTE: Take care not to let the uprights fall, as they are not stable until step 7 is completed.

7. Place a shelf support at the rear of the unit in the bottom keyhole slots, in the same way you placed the shelf support in steps 4 through 6. Then, place a second shelf support at bottom front of unit.

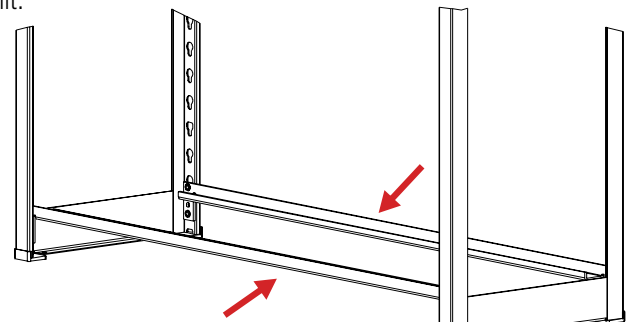

- 8.** Place a shelf (Ref. No. 4) on the unit by inserting it so it nests into the shelf supports. A properly placed shelf will fit flush with the shelf supports as shown below.

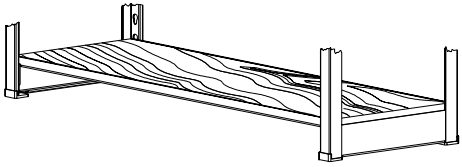
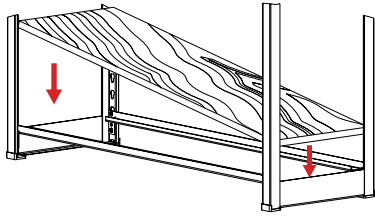

- 9.** Continue the assembly by placing supports and shelves as described in steps 7 and 8. The recommended spacing between the shelves is fifteen inches, (eight open keyhole slots between the supports).

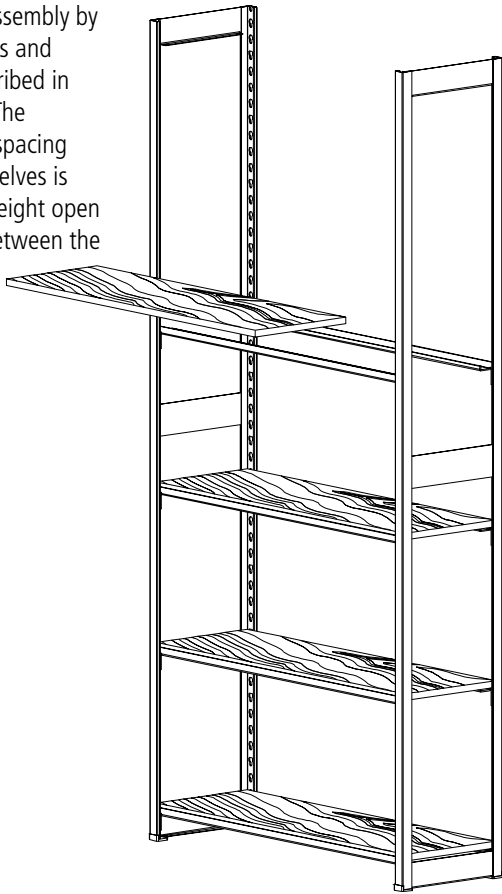

- 10.** The top shelf supports and top shelf should be installed flush with the upright top.

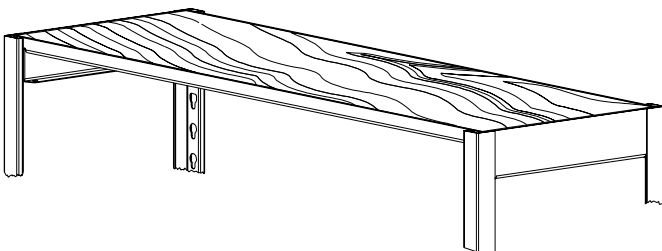

- 11.** If you are assembling only a single unit, assembly is now complete (shown below left). If you are assembling multiple units joined together, your starter unit should have been assembled with a "T" upright (shown below right), as described in step 1. Continue with step 12.

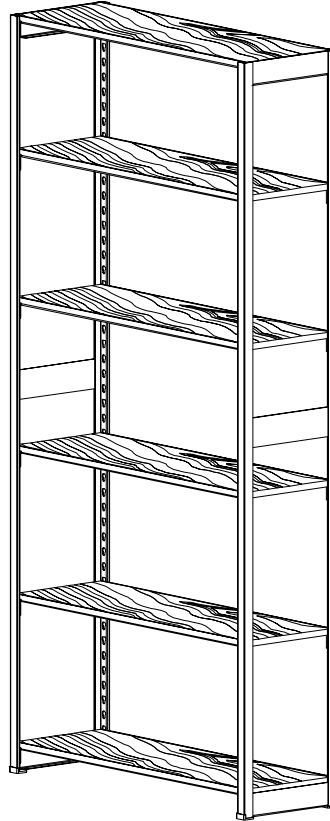

Completed Single Unit

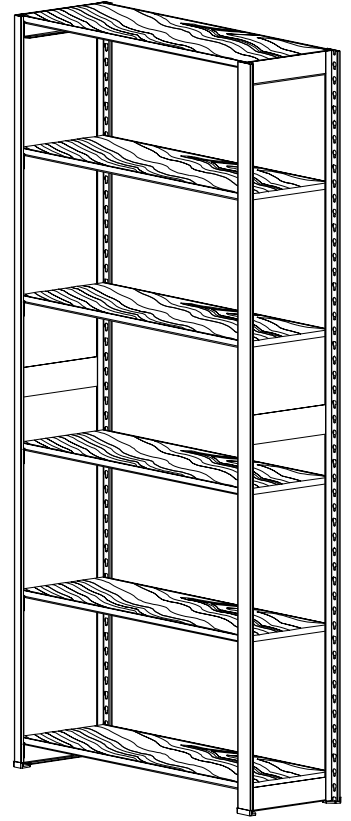

Completed Unit Ready for Add-on

- 12.** Repeat steps 6 through 10, adding the shelf supports to the "T" upright already in place on the unit and finishing with an "L" upright to complete the add-on unit..

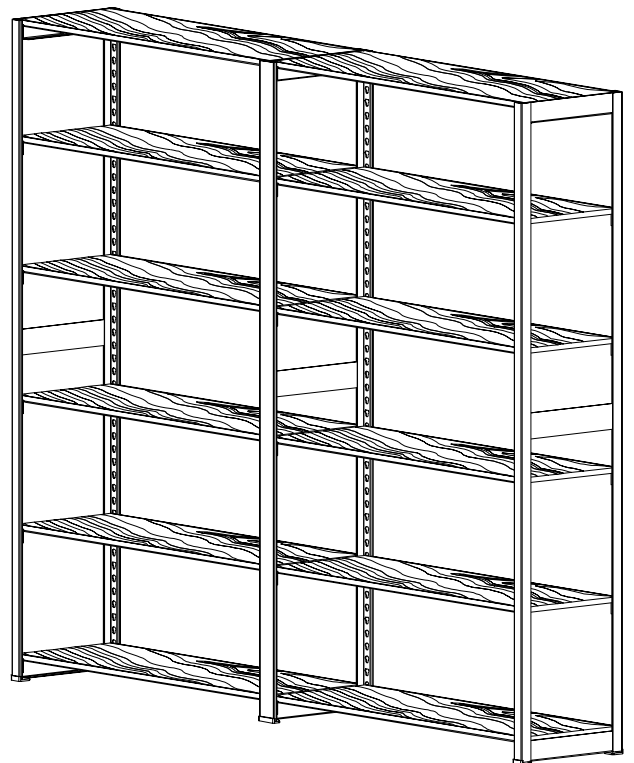

REPLACEMENT PARTS

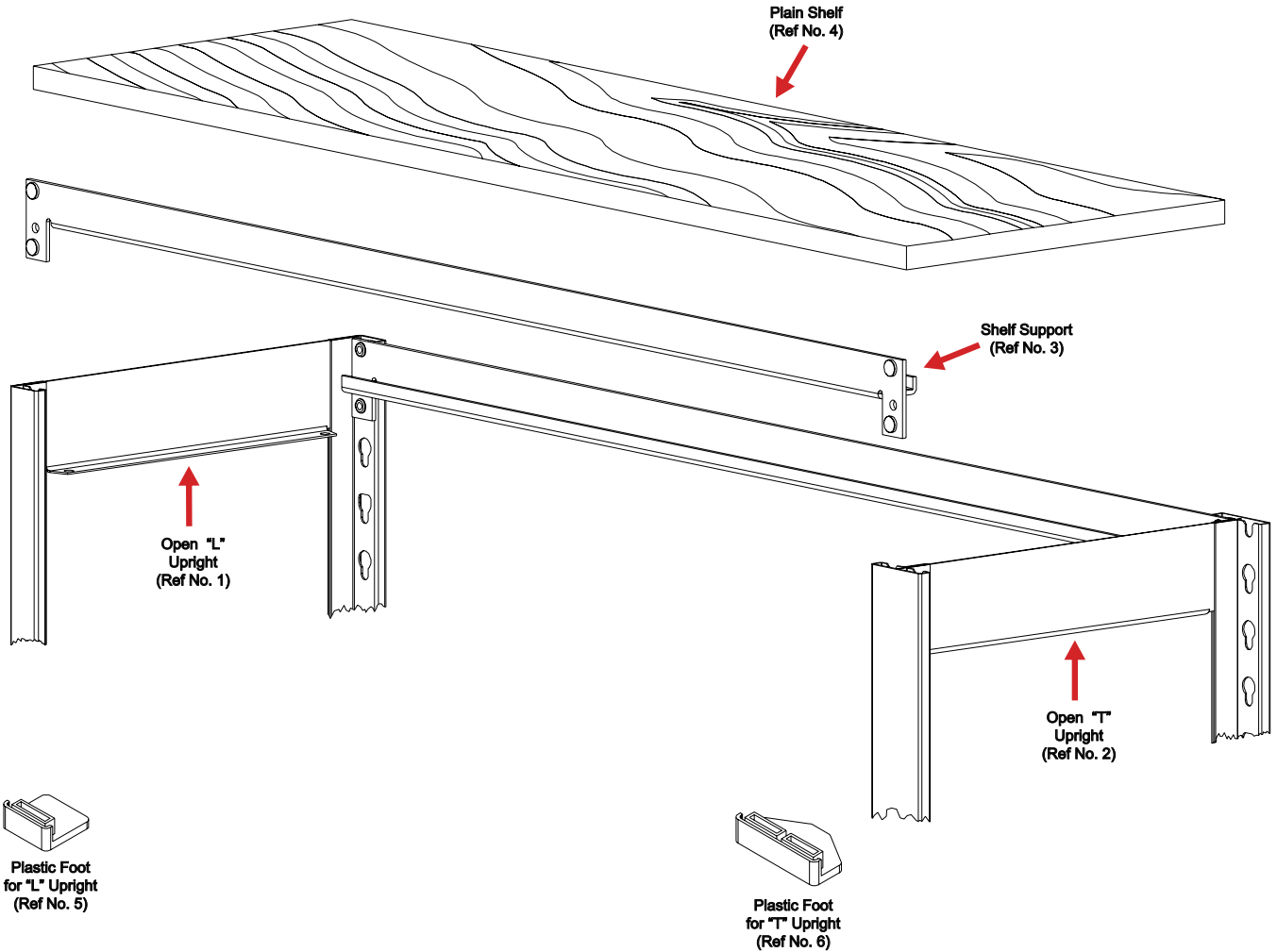

REF. NO.	DESCRIPTION	PART NO.	RGL-1836S Starter 36W x 18D x 76H 5 Openings QUANTITY	RGL-1836A Adder 36W x 18D x 76H 5 Openings QUANTITY
1	Open "L" Upright	1876LO	2	--
2	Closed "T" Upright	1876TO	--	1
3	Shelf Support	HS-3614	12	12
4	Shelf	PBLS-3618	6	6
5	Plastic "L" Foot	LTNF-L	4	--
6	Plastic "T" Foot	LTNF-T	--	2

Optional Sliding Divider Kit (RSKD-12) is available for purchase from your previous purchase location.

Tennsco makes every effort to ensure that all units ship complete with all parts and arrive undamaged. However, should your unit contain missing or damaged parts, please contact your purchase location.