

POLICY AND SERVICES

PRICING: All prices are unassembled, F.O.B. Tennsco Corp's Facility in Dickson, Tennessee. All orders are subject to final acceptance at the Home Office, Dickson, Tennessee. Prices subject to change without notice. Tennsco has the right to make product design changes at any time. Tennsco's prices do not include sales, use, excise or similar taxes. Consequently, in addition to the prices specified herein, the amount of any present or future sales, use, excise or similar tax applicable to the manufacture, sale, purchase or use of the goods sold hereunder shall be paid by Buyer. In lieu thereof, Buyer shall provide Seller with a tax exemption certificate acceptable to the applicable taxing authorities.

TERMS OF PAYMENT: Terms are Net 30 Days from date of shipment. A service charge of 1 1/2% per month will be charged for overdue invoices.

MINIMUM ORDERS: Minimum order is \$15.00.

SPECIFICATIONS: Tennsco reserves the right to change any product specifications contained in this price list.

FREIGHT CHARGES: All shipments will be made freight collect unless otherwise specified. If freight is prepared, it will be added to the invoice or billed separately, depending on arrangements. On shipments by parcel post, the postage will be added to the invoice. All routing will be done solely by the Home Office. If purchaser does not accept delivery of merchandise when ready for shipment, storage fees will be charged to the purchaser.

WEIGHT: Weights shown are approximate.

FREIGHT CLAIMS: Claims for shortages must be made in writing to the Home Office within 15 days from receipt of shipment. Claims for damaged or lost material must be filed with the carrier.

Caution: When you give delivering carrier a clear receipt for a shipment in which there is damaged merchandise or a shortage, the carrier is relieved of further responsibility. Claims for damage or shortage must be filed by you with the delivering carrier. Tennsco will not accept return of merchandise damaged in transit. Your claim is with the delivering carrier.

PARTIAL SHIPMENTS: Tennsco reserves the right to make delivery in installments unless otherwise expressly stated herein. All such installments shall be separately invoiced and paid for when due, without regard to subsequent deliveries. Delay in delivery of all installments shall not relieve Buyer of its obligations to accept remaining deliveries.

SHIPPING TIME: Shipping dates are estimates only, based on standard manufacturing times. Tennsco makes every effort to meet shipping date requests, but will not be held liable for missed shipping dates. Once items are shipped, Tennsco is not responsible for delays caused by the delivering carrier. This includes, but is not limited to, delays in installation proceedings due to slow delivery by carrier.

CANCELLATIONS & RETURNS: Orders for "Special" items are not subject to change or cancellation. No return merchandise will be accepted without written consent of the General Office, Dickson, Tennessee. All returned shipments are subject to a handling charge of 25% plus all transportation charges incurred by Tennsco unless Tennsco is at fault. Once production of "Special" items has begun, cancellation of order is subject to Tennsco approval. A 15% surcharge will be assessed to approved cancelled items.

CODE RESTRICTIONS: Local building codes vary. It is the purchaser's responsibility to determine that product installation is in accordance with local requirements.

LIMITED WARRANTY

Tennsco warrants goods purchased hereunder to be free of defects in materials and workmanship for a period of one (1) year from the date of shipment, hereunder. Tennsco's warranty shall not apply in the event goods are damaged as a result of misuse, abuse, neglect, accident, improper application, modification or repair by persons not authorized by Seller, where goods are damaged during shipment. UNLESS CONSIDERED UNENFORCEABLE OR UNLAWFUL UNDER APPLICABLE LAW:

- ALL IMPLIED WARRANTIES, INCLUDING BUT NOT LIMITED TO WARRANTIES OR MERCHANTABILITY AND FITNESS FOR A PARTICULAR PURPOSE ARE HEREBY EXCLUDED.
- BUYERS REMEDY, IF ANY, FOR ANY DEFECTIVE GOODS SHALL BE LIMITED TO A REFUND BY SELLER OR REPLACEMENT OF THE GOODS AT SELLER'S OPTION AND SHALL IN NO EVENT INCLUDE DAMAGES OF ANY KIND, WHETHER INCIDENTAL, CONSEQUENTIAL OR OTHERWISE.

NO GOODS ACCEPTED FOR RETURN WITHOUT PRIOR APPROVAL. Seller shall have the right to inspect any goods claimed to be defective at Buyer's place of business or require Buyer to return the goods to Seller for inspection on Seller's premises. Transportation charges covering returned goods will be borne by Seller only if such goods are proven to be defective, are covered by this warranty and are returned within the warranty period stated above.

TENNSCO CORP.

Mailing Address: Shipping Address:

P.O. Box 1888 201 Tennsco Drive

Dickson, TN 37056-1888 Dickson, TN 37055

(615) 446-8000 (800) 251-8184 FAX: (800) 722-0134

Website: www.tennsco.com E-Mail: info@tennsco.com

tennsco

Systems for Success

SHELVING PRICE LIST

MAILING ADDRESS:

Tennsco Corp.

P.O. Box 1888

Dickson, TN 37056-1888

SHIPPING ADDRESS:

Tennsco Corp.

201 Tennsco Drive

Dickson, TN 37055

Main Office (800) 251-8184 * FAX: (800) 722-0134

Customer Service: (866) 446-8686 (toll free)

Website: www.tennsco.com * E-mail: info@tennsco.com

EFFECTIVE JUNE 1, 2011

REVISED

This price list supersedes all previous price lists.

Prices subject to change without notice.

CONTENTS:

Z Line Boltless Shelving and Rack:

PAGE 2: Shelf and deck supports

PAGE 3: Shelf and deck supports

PAGE 4: Upright posts

PAGE 5: Particleboard, wire decking

PAGE 6: Steel shelving, doors/sides/back and accessories

PAGE 7: Aisle/wall ties, hang rods and accessories

PAGE 8: Sloped shelves and file drawers

PAGE 9: Drawer kits, power strips and rails

PAGE 10: Record archive and steel shelving units

PAGE 11: Sloped shelving units, die rack units

PAGE 12: Low profile shelving units

PAGE 13: Long span shelving units

Q Line Industrial Shelving:

PAGE 14: Open style units, hinged door units

PAGE 15: Closed style units, ledge units

PAGE 16: Shelves

PAGE 17: Posts, uprights, shelf clips, label holders

PAGE 18: Bin components, sway braces and plates

PAGE 19: End and back panels, sliding dividers, foot plates

PAGE 20: Miscellaneous accessories

Automotive Shelving:

PAGE 21: Preconfigured units and components

Bulk Storage Shelving:

PAGE 22: Upright frames, spacers, extensions

PAGE 23: Decking, beams, and misc. components

PAGE 24: Wire decking components

Slotted Angle:

PAGE 24: Slotted angle, cleat and gusset kit

UNLESS OTHERWISE INDICATED, ALL ITEMS ARE AVAILABLE IN MEDIUM GREY, LIGHT GREY & SAND.

Z LINE PRODUCTS ARE STOCKED IN SAND & MEDIUM GREY; ALL OTHER PRODUCTS ARE STOCKED IN MEDIUM GREY.

NATIONAL MOTOR FREIGHT CLASSIFICATION ON ALL ITEMS EXCEPT PARTICLE BOARD; LTL CLASS 70; TL CLASS 35.

NATIONAL MOTOR FREIGHT CLASSIFICATION ON PARTICLEBOARD: LTL CLASS 50; TL CLASS 55.

TENNSCO QUICK-SHIP PROGRAM



NEED AN ORDER FAST? Look for this logo throughout the book.

Based on past sales history, Tennsco inventories many of its most popular items, usually available for shipment in three business days or less. Quick Ship inventory is available in limited quantities and selected colors. For larger orders, please contact customer service for availability.

♦ Items marked with a red diamond are available for quick ship as noted.



Look for the red diamond!

tennsco

Systems for Success

Z LINE COMPONENTS Shelf Supports, Deck Supports

HEAVY-DUTY SHELF SUPPORTS

◆ QUICKSHIP COLORS: Sand and Medium Grey

CAT. NO.	LOAD CAP.	RECOMMEND # SUPPORTS	LENGTH	WT.	PRICE
LRA-12◆	2250	—	11.5	.9	3.70
LRA-15◆	2250	—	14.5	1.2	4.50
LRA-16	2250	—	15.5	1.3	4.90
LRA-18◆	2250	—	17.5	1.4	4.90
LRA-24◆	2250	—	23.5	1.9	6.10
LRA-30◆	2250	—	29.5	2.3	7.40
LRA-32	2250	—	31.5	2.5	8.80
LRA-36◆	2250	—	35.5	2.8	8.80
LRA-42*◆	2250	1	41.5	3.3	10.40
LRA-48◆	2250	1	47.5	3.7	11.10
LRA-60◆	2000	1	59.5	4.7	14.20
LRA-69*◆	1800	1	68.5	5.4	16.50
LRA-72◆	1750	2	71.5	5.7	17.60
LRA-84◆	1500	3	83.5	6.6	22.00
LRA-96◆	1250	3	95.5	7.5	24.00

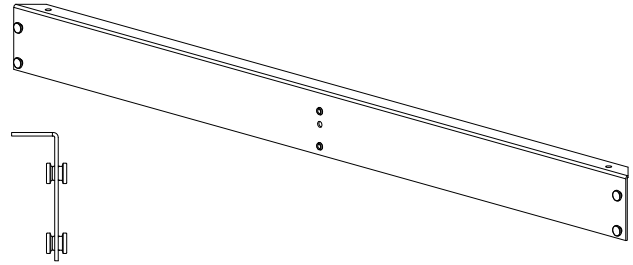

Profile View

Shelf supports are 1" d x 2³/₄" h.
Load capacities are based on above recommended number of SDS-dd front-to-back deck supports.
*42" and 69" sizes are slotted for optional use of archive box rails (ZBR-dd).

EXTRA HEAVY-DUTY CHANNEL SHELF SUPPORTS

◆ QUICKSHIP COLORS: Sand and Medium Grey

CAT. NO.	LOAD CAP.	RECOMMEND # SUPPORTS	LENGTH	WT.	PRICE
LRC-48◆	2500	1	47.5	5.2	14.80
LRC-60	2500	1	59.5	6.2	21.00
LRC-72◆	2500	2	71.5	7.4	22.00
LRC-84	2500	3	83.5	8.7	28.00
LRC-96◆	2500	3	95.5	9.9	29.00

Use left to right only; not to be used front to back.
Can not be installed in bottom two keyholes of uprights; Will not sit flush on the floor.

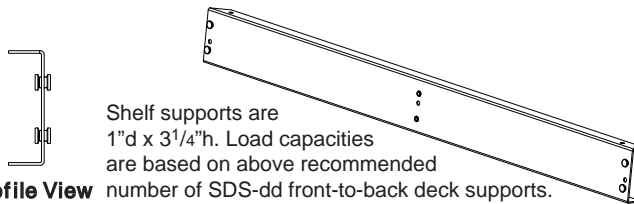

Profile View

Shelf supports are 1" d x 3¹/₄" h. Load capacities are based on above recommended number of SDS-dd front-to-back deck supports.

HEAVY-DUTY FRONT-TO-BACK DECK SUPPORTS (for LRA & LRC)

◆ QUICKSHIP COLORS: Sand and Medium Grey

CAT. NO.	W	D	H	WT.	PRICE
SDS-12◆	1 ³ / ₈	12	2 ³ / ₈	1.0	3.00
SDS-15◆	1 ³ / ₈	15	2 ³ / ₈	1.2	3.50
SDS-16	1 ³ / ₈	16	2 ³ / ₈	1.3	4.20
SDS-18◆	1 ³ / ₈	18	2 ³ / ₈	1.4	4.20
SDS-24◆	1 ³ / ₈	24	2 ³ / ₈	1.9	5.20
SDS-30◆	1 ³ / ₈	30	2 ³ / ₈	2.4	6.50
SDS-32	1 ³ / ₈	32	2 ³ / ₈	2.5	7.40
SDS-36◆	1 ³ / ₈	36	2 ³ / ₈	2.8	7.40
SDS-42	1 ³ / ₈	42	2 ³ / ₈	3.3	9.90
SDS-48◆	1 ³ / ₈	48	2 ³ / ₈	3.8	10.10

Provides center support for decking. Use with LRA-ww or LRC-ww only.



SEISMIC SUPPORT CHANNEL

CAT. NO.	LOAD CAP.	RECOMMEND # SUPPORTS	LENGTH	WT.	PRICE
SSC-36	2750	1	35.5	4.7	14.70
SSC-48	2500	1	47.5	6.3	19.20
SSC-60	2250	1	59.5	7.9	24.00
SSC-72	2000	2	71.5	9.5	28.00
SSC-84	1750	3	83.5	11.1	32.00
SSC-96	1600	3	95.5	12.7	37.00

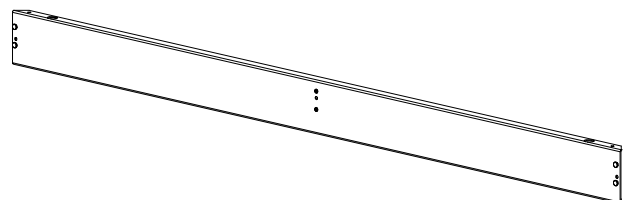

Allows you to secure unit to floor in order to meet seismic requirements.

Z LINE COMPONENTS

Shelf Supports, Deck Supports



MEDIUM DUTY SHELF SUPPORTS

◆ QUICKSHIP COLORS: Sand and Medium Grey



14 Gauge Profile View

◆ QUICKSHIP COLORS: Sand and Medium Grey

14 GAUGE						
CAT. NO.	LOAD CAP.	RECOMMEND # FBSV-DD	LGTH	WT.	PRICE	
VDRS-4814	1000	1	47.5	3.6	12.80	
VDRS-6014◆	750	1	59.5	4.6	15.00	
VDRS-6614	700	1	65.5	5.0	16.30	
VDRS-6914◆	650	2	68.5	5.2	16.90	
VDRS-7214◆	600	2	71.5	5.4	18.30	

Shelf supports are 7/8" d x 2 1/4" h. Supports slotted on 12" centers optional FBSV-dd front to back deck supports (below). Load capacities are based on above recommended number of deck supports.

16 GAUGE						
CAT. NO.	LOAD CAP.	RECOMMEND # FBSV-DD	LGTH	WT.	PRICE	
VDRS-1216	1000	--	11.5	.6	2.70	
VDRS-1516	1000	--	14.5	.8	3.10	
VDRS-1816◆	1000	--	17.5	.9	3.50	
VDRS-2416◆	1000	--	23.5	1.3	4.30	
VDRS-3016◆	1000	--	29.5	1.5	5.30	
VDRS-3616◆	1000	1	35.5	1.8	6.10	
VDRS-4216◆	900	1	41.5	2.2	7.10	
VDRS-4816◆	850	1	47.5	2.5	8.00	

Shelf supports are 7/8" d x 2" h. Supports slotted for optional FBSV-dd front-to-back deck supports (below). Load capacities are based on above recommended number of deck supports.



16 Gauge Profile View

MEDIUM DUTY FRONT TO BACK DECK SUPPORTS (for VDRS)

◆ QUICKSHIP COLORS: Sand and Medium Grey

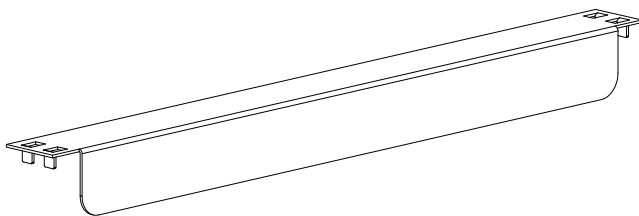

Provides center support for decking. Use with VDRS-wwgg.

CAT. NO.	W	D	H	WT.	PRICE
FBSV-12	13/8	12	23/8	.6	3.30
FBSV-15◆	13/8	15	23/8	.8	3.50
FBSV-18◆	13/8	18	23/8	.9	4.00
FBSV-24◆	13/8	24	23/8	1.3	5.10
FBSV-30◆	13/8	30	23/8	1.6	5.70
FBSV-36◆	13/8	36	23/8	1.9	6.60
FBSV-42	13/8	42	23/8	2.2	8.10
FBSV-48◆	13/8	48	23/8	2.5	9.20

LOW PROFILE SHELF SUPPORTS

◆ QUICKSHIP COLORS: Sand and Medium Grey

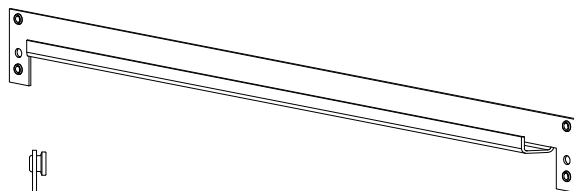

Shelf supports are 27/32" d x 1 1/8" h.

Profile View

CAT. NO.	LOAD CAP.	LENGTH	GA.	WT.	PRICE
DRS-1214◆	600	11.5	14	.5	2.60
DRS-1514◆	600	14.5	14	.7	3.00
DRS-1814◆	600	17.5	14	.9	3.40
DRS-2414◆	600	23.5	14	1.1	3.70
DRS-3014◆	600	29.5	14	1.4	4.30
DRS-3611◆	850	35.5	11	2.8	8.60
DRS-3614◆	600	35.5	14	1.7	5.20
DRS-4211◆	800	41.5	11	3.2	9.40
DRS-4214◆	550	41.5	14	2.0	5.90
DRS-4811◆	750	47.5	11	3.7	10.40
DRS-4814◆	500	47.5	14	2.3	6.60



Look for the red diamond!

STANDARD ANGLE POST

♦ QUICKSHIP COLORS: Sand and Medium Grey

CAT. NO.	W	D	LENGTH	WT.	PRICE
EUR-36♦	1 15/32	1 15/32	36	2.0	6.40
EUR-48♦	1 15/32	1 15/32	48	2.7	9.00
EUR-60♦	1 15/32	1 15/32	60	3.4	10.20
EUR-72♦	1 15/32	1 15/32	72	4.0	12.20
EUR-84♦	1 15/32	1 15/32	84	4.7	14.10
EUR-96♦	1 15/32	1 15/32	96	5.4	16.20
EUR-108♦	1 15/32	1 15/32	108	6.0	18.60
EUR-120♦	1 15/32	1 15/32	120	6.7	20.00
EUR-132	1 15/32	1 15/32	132	7.4	23.00
EUR-144♦	1 15/32	1 15/32	144	8.1	24.00

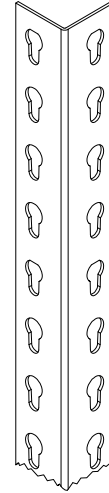

Post slotted for shelf adjustment on 1 1/2" centers. Total weight capacity not to exceed 8,000 lbs. per unit (2,000 lbs. per post), based on 24" centers or less.

INTERMEDIATE POST

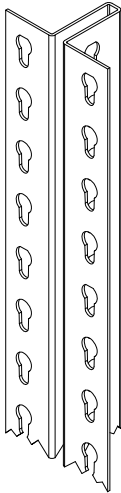

♦ QUICKSHIP COLORS: Sand and Medium Grey

CAT. NO.	W	D	LENGTH	WT.	PRICE
ZTP-36	3 3/8	1 15/32	36	3.9	12.90
ZTP-48♦	3 3/8	1 15/32	48	5.1	16.90
ZTP-60♦	3 3/8	1 15/32	60	6.4	20.00
ZTP-72♦	3 3/8	1 15/32	72	7.7	24.00
ZTP-84♦	3 3/8	1 15/32	84	9.0	28.00
ZTP-96♦	3 3/8	1 15/32	96	10.3	32.00
ZTP-108♦	3 3/8	1 15/32	108	11.6	36.00
ZTP-120♦	3 3/8	1 15/32	120	12.8	40.00
ZTP-132	3 3/8	1 15/32	132	14.1	44.00
ZTP-144♦	3 3/8	1 15/32	144	15.4	47.00

Post slotted for shelf adjustment on 1 1/2" centers. Total weight capacity not to exceed 11,000 lbs. per unit (5,500 lbs. per post), based on 24" centers or less.

HIGH CAPACITY ANGLE POST

♦ QUICKSHIP COLORS: Sand and Medium Grey

CAT. NO.	W	D	LENGTH	WT.	PRICE
SUR-36	2 1/16	2 1/16	36	2.8	9.10
SUR-48	2 1/16	2 1/16	48	3.7	12.30
SUR-60♦	2 1/16	2 1/16	60	4.7	14.40
SUR-72♦	2 1/16	2 1/16	72	5.4	17.10
SUR-84♦	2 1/16	2 1/16	84	6.5	19.90
SUR-96♦	2 1/16	2 1/16	96	7.6	23.00
SUR-108	2 1/16	2 1/16	108	8.5	26.00
SUR-120♦	2 1/16	2 1/16	120	9.2	28.00
SUR-132	2 1/16	2 1/16	132	10.4	32.00
SUR-144♦	2 1/16	2 1/16	144	11.4	34.00
SUR-168	2 1/16	2 1/16	168	13.3	40.00
SUR-181.5	2 1/16	2 1/16	181.5	14.3	43.00

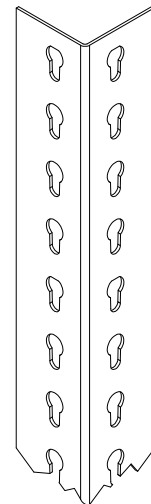

Post slotted for shelf adjustment on 1 1/2" centers. Total weight capacity not to exceed 13,000 lbs. per unit (3,250 lbs. per post), based on 24" centers or less.

Z LINE COMPONENTS

Particleboard and Wire Decking



PARTICLEBOARD DECKING

CAT. NO.	W	D	H	WT.	PRICE
PB-3612♦	36	12	5/8	7.5	5.70
PB-3615♦	36	15	5/8	9.4	6.60
PB-3618♦	36	18	5/8	11.3	8.50
PB-3624♦	36	24	5/8	15.0	11.20
PB-3630♦	36	30	5/8	18.8	14.30
PB-3636♦	36	36	5/8	22.5	16.80
PB-4212♦	42	12	5/8	8.8	7.60
PB-4215♦	42	15	5/8	10.9	8.20
PB-4218♦	42	18	5/8	13.1	10.00
PB-4224♦	42	24	5/8	17.5	13.30
PB-4230♦	42	30	5/8	21.9	16.70
PB-4236♦	42	36	5/8	26.3	20.00
PB-4812♦	48	12	5/8	10.0	8.10
PB-4815♦	48	15	5/8	12.5	9.40
PB-4818♦	48	18	5/8	15.0	11.30
PB-4824♦	48	24	5/8	20.0	13.50
PB-4830♦	48	30	5/8	25.0	18.70
PB-4836♦	48	36	5/8	30.0	20.00
PB-4842♦	48	42	5/8	35.0	31.00
PB-4848♦	48	48	5/8	40.0	30.00
PB-6024♦	60	24	5/8	25.0	18.70
PB-6030♦	60	30	5/8	31.3	24.00
PB-6036♦	60	36	5/8	37.5	28.00
PB-6048♦	60	48	5/8	50.0	38.00
PB-6915♦	69	15	5/8	18.0	13.50
PB-6930♦	69	30	5/8	35.9	34.00
PB-7224♦	72	24	5/8	30.0	26.00
PB-7230♦	72	30	5/8	37.5	28.00
PB-7236♦	72	36	5/8	45.0	34.00
PB-7248♦	72	48	5/8	60.0	45.00
PB-9624♦	96	24	5/8	40.0	30.00
PB-9630♦	96	30	5/8	50.0	37.00
PB-9636♦	96	36	5/8	60.0	45.00
PB-9648♦	96	48	5/8	80.0	60.00

Industrial grade 5/8" thick particleboard provides a sturdy work surface that is both strong and economical.

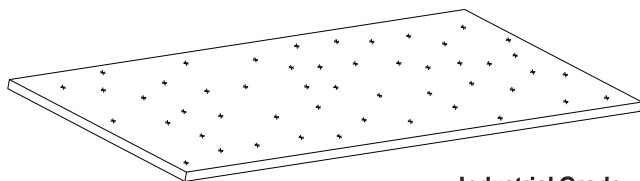

Industrial Grade

WIRE DECKING

♦ QUICKSHIP COLOR: Medium Grey

CAT. NO.	W	D	H	WT.	PRICE
ZWD-3612	36	12	5/16	4.0	24.00
ZWD-3618♦	36	18	5/16	6.0	27.00
ZWD-3624♦	36	24	5/16	8.0	33.00
ZWD-3636♦	36	36	5/16	12.0	49.00
ZWD-4218	42	18	5/16	7.1	38.00
ZWD-4224	42	24	5/16	9.3	46.00
ZWD-4230	42	30	5/16	11.7	48.00
ZWD-4236	42	36	5/16	14.2	48.00
ZWD-4812	48	12	5/16	5.4	26.00
ZWD-4815	48	15	5/16	7.0	37.00
ZWD-4818♦	48	18	5/16	8.0	30.00
ZWD-4824♦	48	24	5/16	10.7	39.00
ZWD-4836♦	48	36	5/16	16.0	59.00
ZWD-4848	48	48	5/16	21.0	85.00
ZWD-6024	60	24	5/16	13.3	66.00
ZWD-6036	60	36	5/16	20.0	81.00
ZWD-6048	60	48	5/16	27.0	110.00
ZWD-6930	69	30	5/16	19.2	78.00
ZWD-7224	72	24	5/16	16.0	60.00
ZWD-7236	72	36	5/16	24.0	82.00
ZWD-7248	72	48	5/16	32.0	92.00
ZWD-9624♦ 96*	24	5/16	21.0	78.00	
ZWD-9630 96*	30	5/16	27.0	118.00	
ZWD-9648 96*	36	5/16	42.0	170.00	

*96"w are two pieces tied together with zip ties.

Wire decking uses 4 gauge wire & consists of a 2" x 4" mesh pattern.

Additional sizes are available; contact factory for pricing. Wire decking is subject to longer than normal lead times; contact factory for specifics. Not recommended for shelf levels with DRS supports deeper than 24".

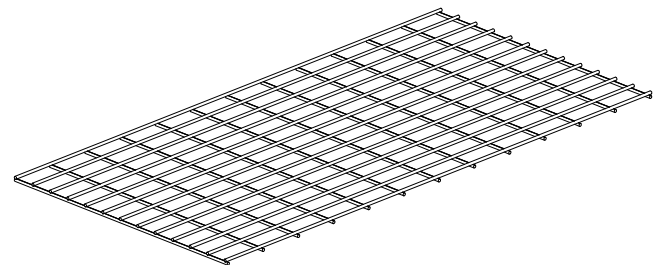



Look for the red diamond!

tennsco

Systems for Success

Z LINE COMPONENTS

Steel Shelves, Doors/Sides/Backs and Accessories

STEEL SHELVES

◆ QUICKSHIP COLOR: Medium Grey

CAT. NO.	W	D	H	WT.	PRICE
ZMS-3612*◆	36	12	15/16	6.7	23.00
ZMS-3618*◆	36	18	15/16	8.8	29.00
ZMS-3624*◆	36	24	15/16	10.9	35.00
ZMS-3636◆	36	36	15/16	17.9	60.00
ZMS-4212*◆	42	12	15/16	7.7	27.00
ZMS-4218*◆	42	18	15/16	10.1	35.00
ZMS-4224*◆	42	24	15/16	12.5	41.00
ZMS-4236◆	42	36	15/16	21.0	67.00
ZMS-4812*◆	48	12	15/16	8.7	29.00
ZMS-4818*◆	48	18	15/16	11.4	36.00
ZMS-4824*◆	48	24	15/16	14.1	44.00
ZMS-4836◆	48	36	15/16	23.0	74.00

REPLACEMENT SHELF CLIPS

CAT. NO.	W	D	H	WT.	PRICE
ZSC-1◆	--	--	--	.1	.80

Attaches to upright posts with four shelf clips per shelf (included).
NOTE: When building your own unit with steel shelves, you **MUST** use VDRS supports at the top and bottom of the unit, on all four sides for stabilization. Shelf clips alone are **NOT** sufficient to support unit. In addition, units 96" and taller must use VDRS supports in the center of the unit, on all four sides. *22 gauge steel \$20 gauge steel

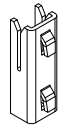
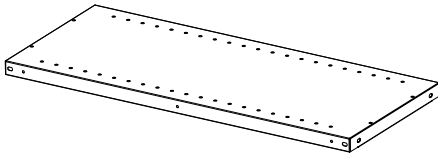

Shelf Clip

Z LINE SIDE AND BACK PANELS

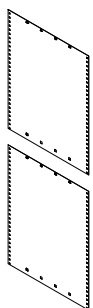

SIDE PANEL

SIDE PANELS					
CAT. NO.	W	D	H	WT.	PRICE
ZLEP-1284	--	12	84	11.5	60.00
ZLEP-1584	--	15	84	14.0	59.00
ZLEP-1884	--	18	84	16.6	66.00
ZLEP-2484	--	24	84	22.0	80.00
ZLEP-3084	--	30	84	27.0	94.00

Side panels fit starter units only; will not fit adder units with ZTP posts. Each side consists of two pieces. Includes 10 attachment clips. Other sizes available; contact factory.

BACK PANELS					
CAT. NO.	W	D	H	WT.	PRICE
ZLBP-3684	36	--	84	35	117.00
ZLBP-4284	42	--	84	42	131.00
ZLBP-4884	48	--	84	48	145.00

Back consists of two pieces. Includes 10 attachment clips. Other sizes available; contact factory.

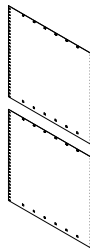

BACK PANEL

SHELF DIVIDER

CAT. NO.	W	D	H	WT.	PRICE
DIV2410	--	24	10	4.4	15.40

Use on particleboard, front-to-back, to subdivide shelf into several storage areas.

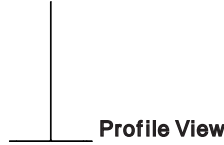

Profile View

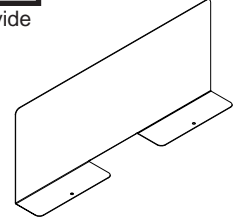

BOX RAILS

◆ QUICKSHIP COLOR: Sand

CAT. NO.	W	D	H	WT.	PRICE
ZBR-15◆	13/8	15	23/8	.8	3.80
ZBR-30◆	13/8	30	23/8	1.6	6.10

Used for archive box storage. Used with 42" and 69" LRA shelf supports only.

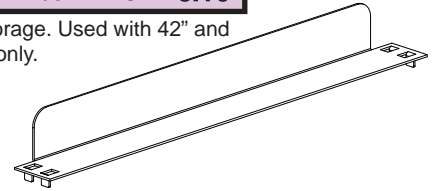

Z LINE CASTER KIT

CAT. NO.	CASTERS	W	D	H	WT.	PRICE
ZLCK-1	2 fixed, 2 Swivel	11/2	11/2	7/16	12.8	141.00
ZLCK-2	4 Swivel	37/16	2	7/16	13.0	143.00

Load capacity for caster kit is 1,000 lbs. Casters should not be used with units over 96" tall, or on units less than 18" deep. Maximum unit size is 48" wide by 30" deep.

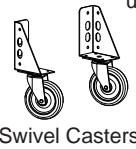

Swivel Casters

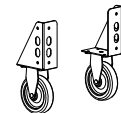

Fixed Casters

Z LINE HINGED DOORS

(13/16" d x 84" h)

CAT. NO.	W	WT.	PRICE
ZLHD-3684	36 1/8	52	459.00
ZLHD-4284	42 1/8	59	521.00
ZLHD-4884	48 1/8	64	536.00

Extends 13/16" from front of unit (not including handle). Hinged door comes standard with one recessed handle, which protrudes an additional 1/2".

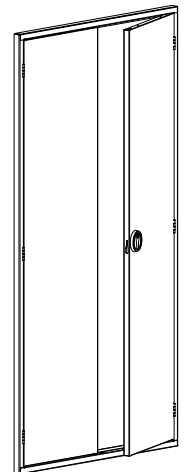



Z LINE COMPONENTS

Aisle/Wall Ties, Hang Rods and Accessories



HANG RODS

♦ QUICKSHIP COLORS: Sand and Medium Grey

CAT. NO.	W	D	H	LOAD CAP	WT.	PRICE
FOR LRA OR LRC SUPPORTS						
Channel-Shaped Hang Rods						
PHR-36♦	36 ¹ / ₄	1 ⁵ / ₁₆	1 ¹¹ / ₁₆	150	2.9	9.70
PHR-48♦	48 ¹ / ₄	1 ⁵ / ₁₆	1 ¹¹ / ₁₆	150	3.8	12.00
Round Hang Rods						
OHR-36	36	1 ¹ / ₄ Diameter		150	2.5	8.90
OHR-48	48	1 ¹ / ₄ Diameter		150	3.3	12.90
FOR DRS SUPPORTS						
ZHR-36♦	36 ³ / ₁₆	7/8	1 ¹¹ / ₁₆	150	2.3	7.50
ZHR-48♦	48 ³ / ₁₆	7/8	1 ¹¹ / ₁₆	150	3.1	9.90

Used for hanging items left-to-right on a Z line unit. Attaches between two shelf supports.

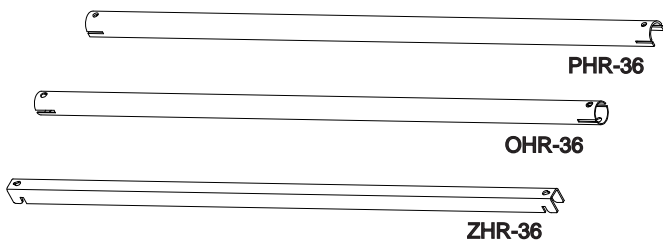

AISLE TIES

♦ QUICKSHIP COLORS: Sand and Medium Grey

CAT. NO.	W	D	H	WT.	PRICE
CROSS AISLE TIES					
CAT-18♦	1 ³ / ₈	18	2 ³ / ₈	1.4	9.20
CAT-24	1 ³ / ₈	24	2 ³ / ₈	1.9	10.10
CAT-30	1 ³ / ₈	30	2 ³ / ₈	2.4	12.20
CAT-36♦	1 ³ / ₈	36	2 ³ / ₈	2.8	13.00
CAT-42	1 ³ / ₈	42	2 ³ / ₈	3.3	14.40
CAT-48	1 ³ / ₈	48	2 ³ / ₈	3.8	18.70
ADJUSTABLE AISLE TIE					
KCAT-1♦	3	*	1	5.3	25.00

Used to link units across an aisle for extra stability. Adjustable Aisle Tie links units across an aisle at adjustable distances.

*Depth adjusts from 36" to 60"

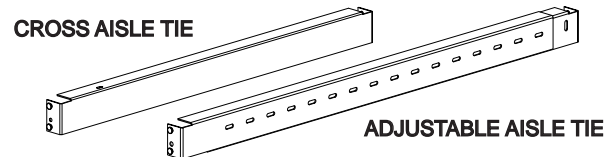

PROTECTIVE CAPS

♦ QUICKSHIP COLOR: Black

CAT. NO.	FITS	W	D	H	WT.	PRICE
SOFT TOP EDGE CAPS						
EURPC♦	EUR uprights	1 ¹ / ₂	1 ¹ / ₂	7/16	0.1	.81
ZTPPC♦	ZTP uprights	3 ⁷ / ₁₆	2	7/16	0.1	1.20
SURPC♦	SUR uprights	1 ³ / ₄	2 ³ / ₄	7/16	0.1	.78
HARD NYLON FOOT CAPS						
EURNF♦	EUR uprights	1 ¹ / ₂	1 ¹ / ₂	3/4	0.1	.73
ZTPNF♦	ZTP uprights	3 ⁷ / ₁₆	2	3/4	0.2	1.20
SURNF♦	SUR uprights	1 ³ / ₄	2 ³ / ₄	3/4	0.2	1.00

Place top edge caps over top of upright end to protect from sharp edges. Place foot caps beneath uprights as a floor protector.

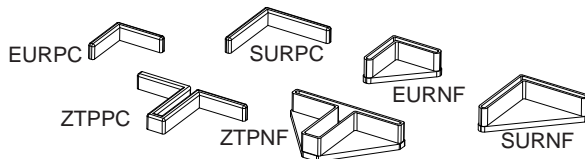

WALL TIE

♦ QUICKSHIP COLORS: Sand and Medium Grey

CAT. NO.	W	D	H	WT.	PRICE
WT-9♦	9 ¹ / ₄	1 ³ / ₈	2 ³ / ₈	.7	4.50

Used to secure a unit to a wall, with a 9" gap between the unit and the wall.

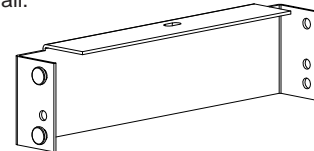

TIE PLATE

♦ QUICKSHIP COLORS: Sand and Medium Grey

CAT. NO.	W	D	H	WT.	PRICE
TP-1♦	3	--	2 ³ / ₄	.2	1.40

Used to secure two angle posts together front-to-back or side-by-side.

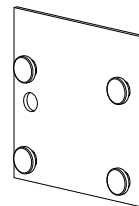

POST SPLICE ANGLE

CAT. NO.	W	D	H	WT.	PRICE
PSA-2	1 ⁹ / ₁₆	1 ⁹ / ₁₆	6 ¹ / ₂	.5	6.10

Includes hardware. Used for splicing EUR, SUR and ZTP upright posts. When splicing ZTP uprights, two post splice angles are required.

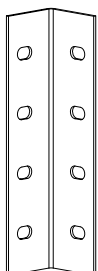

ANCHOR PLATE

♦ QUICKSHIP COLORS: Sand and Medium Grey

CAT. NO.	W	D	H	WT.	PRICE
ZFA-1♦	1 ³ / ₈	1 ¹ / ₂	2 ³ / ₈	.2	2.50

Attaches to uprights to allow anchoring uprights to the floor.

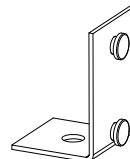

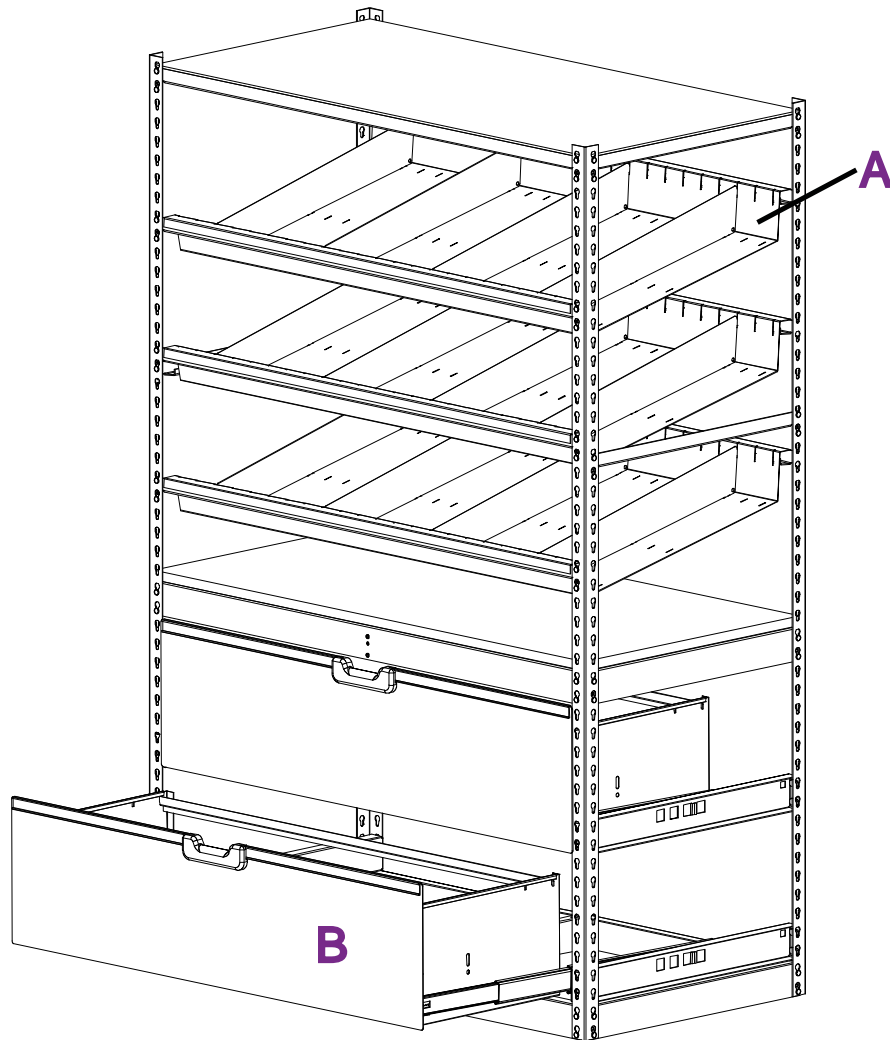

A) BIN STYLE SLOPED SHELVES

CAT. NO.	W	D	H	WT.	PRICE
ZLBS-3618	36	18	4	27.9	104.00
ZLBS-3624	36	24	4	33.6	121.00
ZLBS-4218	42	18	4	31.1	115.00
ZLBS-4224	42	24	4	37.4	133.00
ZLBS-4818	48	18	4	34.8	124.00
ZLBS-4824	48	24	4	41.6	143.00

Z LINE BIN SHELF DIVIDER

ZLBD-18	1/16	18	4	1.0	4.00
ZLBD-24	1/16	24	4	1.3	4.30

Levels include 1 sloping shelf, 2 DRS supports and 8 shelf dividers.

B) FILE DRAWERS

CAT. NO.	W	D	H	WT.	PRICE
ZFD-3618	36	18	117/16	32.0	319.00
ZFD-4218	42	18	117/16	34.0	327.00
ZFD-4818	48	18	117/16	35.0	336.00
ZFD-3624	36	24	117/16	43.0	409.00
ZFD-4224	42	24	117/16	46.0	428.00
ZFD-4824	48	24	117/16	47.0	447.00

File drawers include hanging folder rods. Drawers are single entry only.

Z LINE COMPONENTS

Drawer Kits, Power Strips and Rails



C) POWER STRIPS

CAT. NO.	W	D	H	WT.	PRICE
ZPS-36	36	—	—	10.8	239.00
ZPS-42	42	—	—	12.2	243.00
ZPS-48	48	—	—	13.7	248.00

Pre-wired for quick installation. Comes complete with four duplex receptacles, on/off switch with pilot light, 8 foot grounded cord and plug, 15 amp, 115 volt service and circuit breaker. Use with electronic riser, outlet panels, or electronic workbench.

D) BIN RAILS

CAT. NO.	W	D	H	WT.	PRICE
ZHBR-36	36	—	—	9.6	72.00
ZHBR-42	42	—	—	11.1	78.00
ZHBR-48	48	—	—	12.5	84.00

Tennsco DOES NOT sell bin boxes for bin rails.

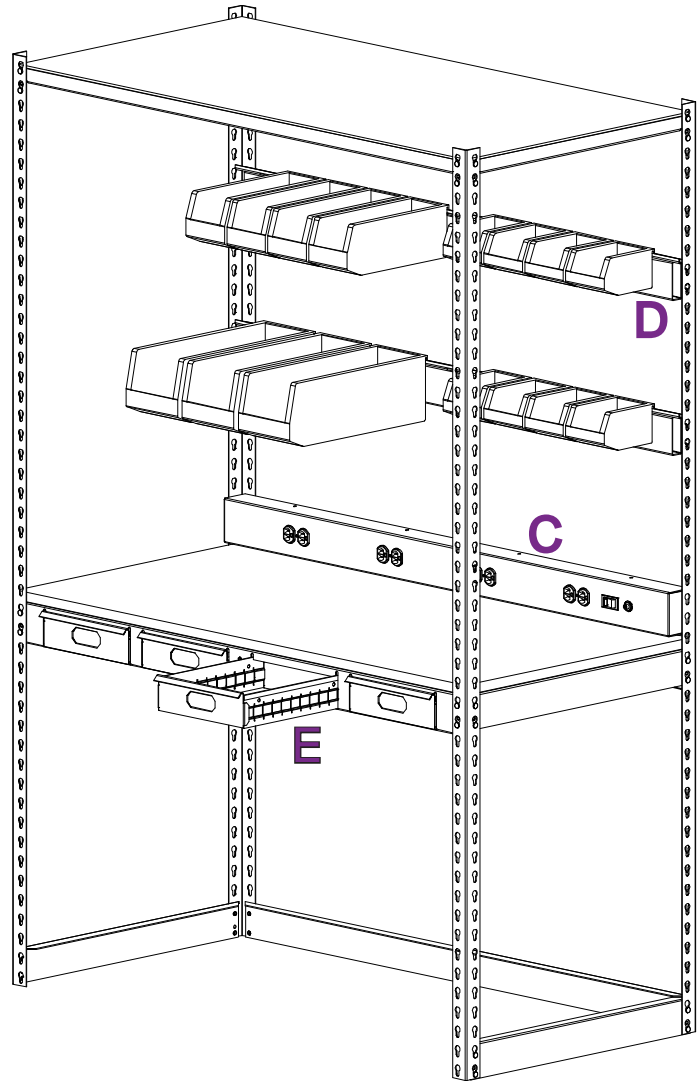

E) STEEL BIN DRAWER KIT

CAT. NO.	# OF DRAWERS	W	D	H	WT.	PRICE
Single Entry						
ZSBD-3618S	3	36	18	12	25.4	145.00
ZSBD-3624S	3	36	24	12	28.1	153.00
ZSBD-3630S	3	36	30	12	30.9	163.00
ZSBD-4218S	3	42	18	12	27.0	152.00
ZSBD-4224S	3	42	24	12	29.7	160.00
ZSBD-4230S	3	42	30	12	32.5	169.00
ZSBD-4818S	4	48	18	12	31.9	182.00
ZSBD-4824S	4	48	24	12	35.3	192.00
ZSBD-4830S	4	48	30	12	38.7	204.00

CAT. NO.	# OF DRAWERS	W	D	H	WT.	PRICE
Double Entry						
ZSBD-3624D	6	36	24	12	31.8	181.00
ZSBD-3630D	6	36	30	12	34.6	191.00
ZSBD-4224D	6	42	24	12	33.4	188.00
ZSBD-4230D	6	42	30	12	36.2	197.00
ZSBD-4824D	8	48	24	12	40.2	230.00
ZSBD-4830D	8	48	30	12	43.6	242.00
OPTIONAL DIVIDERS (PACK OF 30)						
CAT. NO.	W	D	H	WT.	PRICE	
30AD	27/8	—	9 ¹ / ₁₆	6.7	46.00	

Level includes drawers, front and rear supports, guide rails and front to back reinforcements. Inside drawer dimensions: 9 x 11¹/₄ x 2³/₄



Look for the red diamond!

RECORD ARCHIVE STORAGE RACKS

♦ QUICKSHIP COLORS: Medium Grey and Sand

UNIT SIZE W D H	NO. OF OPENINGS	CUSTOMER SUPPLIES DECKING			WITH PARTICLEBOARD DECKING			WITH ANGLE BOX SUPPORTS		
		CAT. NO.	WT.	PRICE	CAT. NO.	WT.	PRICE	CAT. NO.	WT.	PRICE
42 15 60	2	ZA421560-3♦	41	130.00	ZA421560-3D♦	73	155.00	ZB421560-3♦	55	199.00
42 15 84	3	ZA421584-4♦	55	176.00	ZA421584-4D♦	98	208.00	ZB421584-4♦	74	267.00
42 30 60	2	ZA423060-3♦	47	148.00	ZA423060-3D♦	113	198.00	ZB423060-3♦	76	257.00
42 30 84	3	ZA423084-4♦	64	199.00	ZA423084-4D♦	151	266.00	ZB423084-4♦	102	345.00
69 15 60	2	ZA691560-3♦	57	177.00	ZA691560-3D♦	111	218.00	ZB691560-3♦	81	291.00
69 15 84	3	ZA691584-4♦	76	238.00	ZA691584-4D♦	148	292.00	ZB691584-4♦	108	390.00
69 30 60	2	ZA693060-3♦	67	204.00	ZA693060-3D♦	175	306.00	ZB693060-3♦	115	387.00
69 30 84	3	ZA693084-4♦	90	274.00	ZA693084-4D♦	234	410.00	ZB693084-4♦	154	518.00

CUSTOMER TO SUPPLY DECKING

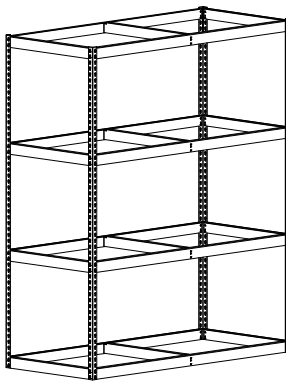

SUPPLIED WITH DECKING

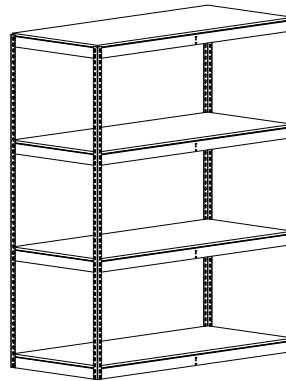

SUPPLIED WITH ANGLE BOX SUPPORTS

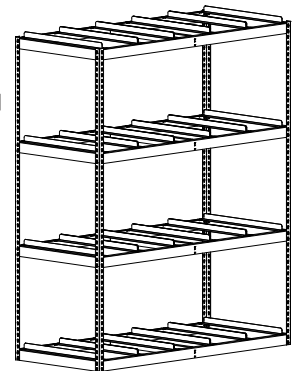

STEEL SHELVING UNITS

♦ QUICKSHIP COLORS: Medium Grey

UNIT SIZE W D H	LOAD CAP.*	STARTER UNITS		ADDER UNITS		EXTRA SHELF LEVELS	
		CAT. NO.	WT. PRICE	CAT. NO.	WT. PRICE	CAT. NO.	WT. PRICE
36 12 84	750	ZM7-3612S-5D♦	61 201.00	ZM7-3612A-5D♦	59 195.00	ZMS-3612♦	6.7 23.00
36 18 84	750	ZM7-3618S-5D♦	73 234.00	ZM7-3618A-5D♦	70 227.00	ZMS-3618♦	8.8 29.00
36 24 84	700	ZM7-3624S-5D♦	85 268.00	ZM7-3624A-5D♦	82 259.00	ZMS-3624♦	10.9 35.00
36 36 84	600	ZM7-3636S-5D♦	122 400.00	ZM7-3636A-5D♦	118 387.00	ZMS-3636♦	17.9 60.00
42 12 84	600	ZM7-4212S-5D♦	68 225.00	ZM7-4212A-5D♦	66 219.00	ZMS-4212♦	7.7 27.00
42 18 84	600	ZM7-4218S-5D♦	81 268.00	ZM7-4218A-5D♦	78 261.00	ZMS-4218♦	10.1 35.00
42 24 84	550	ZM7-4224S-5D♦	95 302.00	ZM7-4224A-5D♦	91 293.00	ZMS-4224♦	12.5 41.00
42 36 84	550	ZM7-4236S-5D	137 439.00	ZM7-4236A-5D	132 426.00	ZMS-4236	21.0 67.00
48 12 84	500	ZM7-4812S-5D♦	74 239.00	ZM7-4812A-5D♦	72 233.00	ZMS-4812♦	8.7 29.00
48 18 84	500	ZM7-4818S-5D♦	89 277.00	ZM7-4818A-5D♦	86 270.00	ZMS-4818♦	11.4 36.00
48 24 84	450	ZM7-4824S-5D♦	104 320.00	ZM7-4824A-5D♦	100 311.00	ZMS-4824♦	14.1 44.00
48 36 84	450	ZM7-4836S-5D♦	150 477.00	ZM7-4836A-5D♦	146 465.00	ZMS-4836♦	23.0 74.00

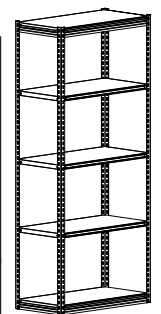

STARTER UNIT



ADDER UNIT

Starter units use 4 EUR uprights; adder units use 2 ZTP uprights. *Load capacity figures are calculated in pounds per shelf level. Each unit is stabilized by VDRS shelf supports at both top and bottom. Intermediate shelves are attached by 4 ZSC-1 shelf clips (included). Total unit capacity, using four EUR uprights, not to exceed 8000 lbs., based on 24" centers or less.

Z LINE SHELVING

Sloping Shelving Units, Die Rack Unit

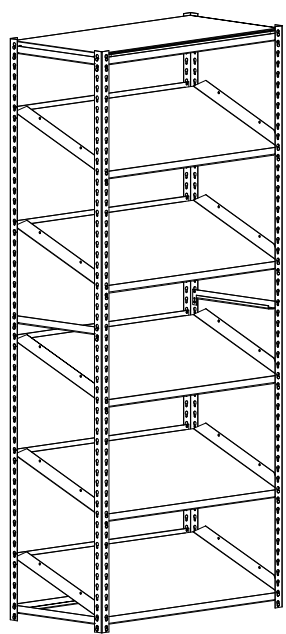

SLOPING SHELF UNITS

FLAT SLOPE STYLE

◆ QUICKSHIP COLOR: Medium Grey

CAT. NO.	W	D	H	WT.	PRICE
STARTER UNITS					
ZT7-3618S-5◆	36	18	84	138	433.00
ZT7-3624S-5◆	36	24	84	161	512.00
ZT7-4818S-5◆	48	18	84	188	569.00
ZT7-4824S-5◆	48	24	84	219	666.00
ADDER UNITS					
ZT7-3618A-5◆	36	18	84	138	435.00
ZT7-3624A-5◆	36	24	84	161	514.00
ZT7-4818A-5◆	48	18	84	188	571.00
ZT7-4824A-5◆	48	24	84	219	668.00
EXTRA SHELF LEVELS					
ZSSS-3618	36	18	—	17.9	81.00
ZSSS-3624	36	24	—	23.0	94.00
ZSSS-4818	48	18	—	27.0	106.00
ZSSS-4824	48	24	—	33.0	123.00

◆ QUICKSHIP COLOR: Medium Grey

CAT. NO.	W	D	H	LOAD CAP.*	WT.	PRICE
RXHS-361872◆	36	18	72	4000	147	508.00
RXHS-362472◆	36	24	72	4000	202	595.00
RXHS-481872◆	48	18	72	4000	181	603.00
RXHS-482472◆	48	24	72	4000	214	693.00
RXHS-602472◆	60	24	72	3250	255	811.00
RXHS-722472◆	72	24	72	2750	305	948.00
RXHS-361884◆	36	18	84	4000	151	517.00
RXHS-362484◆	36	24	84	4000	210	604.00
RXHS-481884◆	48	18	84	4000	185	612.00
RXHS-482484◆	48	24	84	4000	218	702.00
RXHS-602484◆	60	24	84	3250	259	820.00
RXHS-722484◆	72	24	84	2750	309	957.00
RXHS-723684◆	72	36	84	2750	419	1,255.00
RXHS-962484◆	96	24	84	2600	418	1,310.00
RXHS-963684◆	96	36	84	2600	565	1,685.00
RXHS-361896◆	36	18	96	4000	155	532.00
RXHS-362496◆	36	24	96	4000	218	619.00
RXHS-481896◆	48	18	96	4000	189	627.00
RXHS-482496◆	48	24	96	4000	222	717.00
RXHS-602496◆	60	24	96	3250	263	835.00
RXHS-722496◆	72	24	96	2750	313	972.00
RXHS-723696◆	72	36	96	2750	425	1,270.00
RXHS-962496◆	96	24	96	2600	422	1,325.00
RXHS-963696◆	96	36	96	2600	570	1,700.00

DIE RACK UNIT

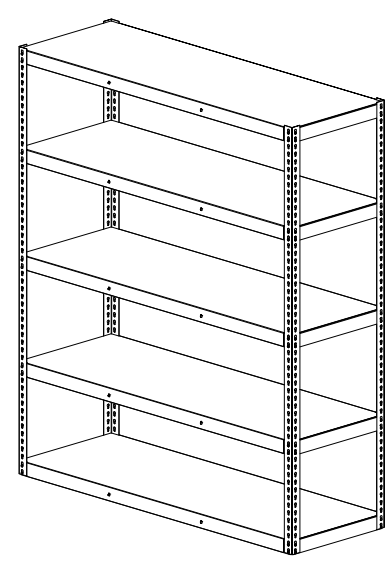

◆ QUICKSHIP COLOR: Medium Grey

EXTRA SHELF LEVELS						
CAT. NO.	W	D	H	WT.	PRICE	
RXHS-3618◆	36	18	21 ^{1/16}	25	102.00	
RXHS-3624◆	36	24	21 ^{1/16}	32	117.00	
RXHS-4818◆	48	18	21 ^{1/16}	32	122.00	
RXHS-4824◆	48	24	21 ^{1/16}	40	140.00	
RXHS-6024◆	60	24	21 ^{1/16}	47	168.00	
RXHS-7224◆	72	24	21 ^{1/16}	57	192.00	
RXHS-7236◆	72	36	21 ^{1/16}	79	237.00	
RXHS-9624◆	96	24	21 ^{1/16}	80	251.00	
RXHS-9636◆	96	36	21 ^{1/16}	109	326.00	

*Load capacities are, per shelf, based on shelves spaced on 24" centers. Weight not to exceed a total of 13,000 lbs. per unit. Reinforcements (SDS-dd) included per shelf level: One on all 36"w, 48"w, and 60"w units; two on all 72"w units; three on all 96"w units. Available in Medium Grey only. Other heights are available; call factory for pricing.



Look for the red diamond!

Z LINE SHELVING Low Profile Shelving Units

4 SHELVES, 3 OPENINGS ---- With Particleboard Decking

♦ QUICKSHIP COLORS: Sand and Medium Grey

UNIT SIZE W D H	LOAD CAP.*	STARTER UNITS			ADDER UNITS			EXTRA SHELF LEVELS		
		CAT. NO.	WT.	PRICE	CAT. NO.	WT.	PRICE	CAT. NO.	WT.	PRICE
36 12 84	600	ZA7-3612S-4D♦	65	136.00	ZA7-3612A-4D♦	63	128.00	ZAES-3612D♦	10.9	16.10
36 18 84	600	ZA7-3618S-4D♦	83	152.00	ZA7-3618A-4D♦	80	142.00	ZAES-3618D♦	14.7	18.90
36 24 84	600	ZA7-3624S-4D♦	99	165.00	ZA7-3624A-4D♦	95	154.00	ZAES-3624D♦	18.4	22.00
36 36 84	600	ZA7-3636S-4D♦	136	207.00	ZA7-3636A-4D♦	135	206.00	ZAES-3636D♦	29.0	38.00
42 12 84	550	ZA7-4212S-4D♦	73	150.00	ZA7-4212A-4D♦	71	141.00	ZAES-4212D♦	12.8	19.40
42 18 84	550	ZA7-4218S-4D♦	93	164.00	ZA7-4218A-4D♦	89	153.00	ZAES-4218D♦	17.1	22.00
42 24 84	550	ZA7-4224S-4D♦	111	179.00	ZA7-4224A-4D♦	107	168.00	ZAES-4224D♦	22.0	25.00
42 36 84	550	ZA7-4236S-4D♦	154	225.00	ZA7-4236A-4D♦	153	225.00	ZAES-4236D♦	34.0	42.00
48 12 84	500	ZA7-4812S-4D♦	80	157.00	ZA7-4812A-4D♦	78	149.00	ZAES-4812D♦	14.6	21.00
48 18 84	500	ZA7-4818S-4D♦	103	175.00	ZA7-4818A-4D♦	99	164.00	ZAES-4818D♦	19.6	25.00
48 24 84	500	ZA7-4824S-4D♦	124	185.00	ZA7-4824A-4D♦	120	174.00	ZAES-4824D♦	25.0	27.00
48 36 84	500	ZA7-4836S-4D♦	171	231.00	ZA7-4836A-4D♦	170	230.00	ZAES-4836D♦	38.0	44.00

4 SHELVES, 3 OPENINGS ---- Without Decking

♦ QUICKSHIP COLORS: Sand and Medium Grey

UNIT SIZE W D H	LOAD CAP.*	STARTER UNITS			ADDER UNITS			EXTRA SHELF LEVELS		
		CAT. NO.	WT.	PRICE	CAT. NO.	WT.	PRICE	CAT. NO.	WT.	PRICE
36 12 84	600	ZA7-3612S-4♦	35	114.00	ZA7-3612A-4♦	33	105.00	ZAES-3612♦	3.4	10.40
36 18 84	600	ZA7-3618S-4♦	38	118.00	ZA7-3618A-4♦	34	108.00	ZAES-3618♦	3.4	10.40
36 24 84	600	ZA7-3624S-4♦	39	120.00	ZA7-3624A-4♦	35	109.00	ZAES-3624♦	3.4	10.40
36 36 84	600	ZA7-3636S-4♦	46	140.00	ZA7-3636A-4♦	45	139.00	ZAES-3636♦	6.8	21.00
42 12 84	550	ZA7-4212S-4♦	38	119.00	ZA7-4212A-4♦	36	111.00	ZAES-4212♦	4.0	11.80
42 18 84	550	ZA7-4218S-4♦	40	124.00	ZA7-4218A-4♦	37	113.00	ZAES-4218♦	4.0	11.80
42 24 84	550	ZA7-4224S-4♦	41	126.00	ZA7-4224A-4♦	37	114.00	ZAES-4224♦	4.0	11.80
42 36 84	550	ZA7-4236S-4♦	48	145.00	ZA7-4236A-4♦	48	145.00	ZAES-4236♦	7.4	22.00
48 12 84	500	ZA7-4812S-4♦	40	125.00	ZA7-4812A-4♦	38	117.00	ZAES-4812♦	4.6	13.20
48 18 84	500	ZA7-4818S-4♦	43	130.00	ZA7-4818A-4♦	39	119.00	ZAES-4818♦	4.6	13.20
48 24 84	500	ZA7-4824S-4♦	44	131.00	ZA7-4824A-4♦	40	120.00	ZAES-4824♦	4.6	13.20
48 36 84	500	ZA7-4836S-4♦	51	151.00	ZA7-4836A-4♦	50	150.00	ZAES-4836♦	8.0	24.00

Starter units use four EUR uprights and six DRS end supports; adder units use two ZTP uprights and three DRS end supports. Shelves are supported, on front and rear only, by low profile shelf supports (DRS-dd).

36" deep shelves are supported on all four sides.

*Load capacity in pounds per shelf level. Total unit capacity, using four uprights, not to exceed 8,000 lbs., based on 24" centers or less.

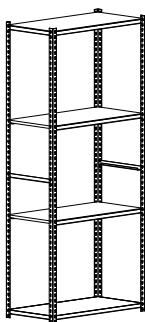

STARTER UNIT WITH DECKING

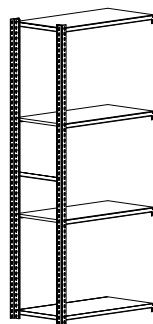

ADD-ON UNIT WITH DECKING

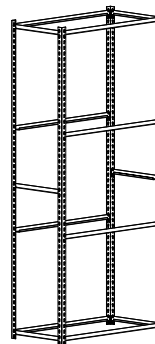

STARTER UNIT WITHOUT DECKING

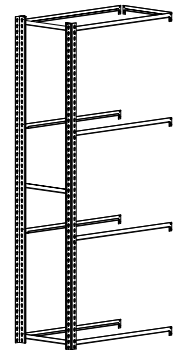

ADD-ON UNIT WITHOUT DECKING

Z LINE SHELVING

Long Span Shelving Units



HEAVY DUTY LONG SPAN SHELVING

With Particleboard Decking

♦ QUICKSHIP COLORS: Sand and Medium Grey

3 SHELVES (2 OPENINGS)							EXTRA SHELF LEVELS		
CAT. NO.	W	D	H	LOAD CAP.	WT.	PRICE	CAT. NO.	WT.	PRICE
ZL7-4824-3D ♦	48	24	84	2250	125	239.00	ZLES-4824D ♦	33	53.00
ZL7-4830-3D ♦	48	30	84	2250	144	266.00	ZLES-4830D ♦	39	62.00
ZL7-4836-3D ♦	48	36	84	2250	163	281.00	ZLES-4836D ♦	46	67.00
ZL7-4848-3D ♦	48	48	84	2250	202	333.00	ZLES-4848D ♦	59	85.00
ZL7-6024-3D ♦	60	24	84	2000	146	273.00	ZLES-6024D ♦	40	65.00
ZL7-6030-3D ♦	60	30	84	2000	169	301.00	ZLES-6030D ♦	48	74.00
ZL7-6036-3D ♦	60	36	84	2000	192	324.00	ZLES-6036D ♦	55	81.00
ZL7-6048-3D ♦	60	48	84	2000	238	376.00	ZLES-6048D ♦	71	99.00
ZL7-7224-3D ♦	72	24	84	1750	173	331.00	ZLES-7224D ♦	49	84.00
ZL7-7230-3D ♦	72	30	84	1750	201	353.00	ZLES-7230D ♦	58	91.00
ZL7-7236-3D ♦	72	36	84	1750	229	384.00	ZLES-7236D ♦	68	102.00
ZL7-7248-3D ♦	72	48	84	1750	285	447.00	ZLES-7248D ♦	86	123.00
ZL7-9624-3D ♦	96	24	84	1250	220	397.00	ZLES-9624D ♦	65	106.00
ZL7-9630-3D ♦	96	30	84	1250	256	438.00	ZLES-9630D ♦	77	119.00
ZL7-9636-3D ♦	96	36	84	1250	293	478.00	ZLES-9636D ♦	89	133.00
ZL7-9648-3D ♦	96	48	84	1250	367	561.00	ZLES-9648D ♦	114	161.00

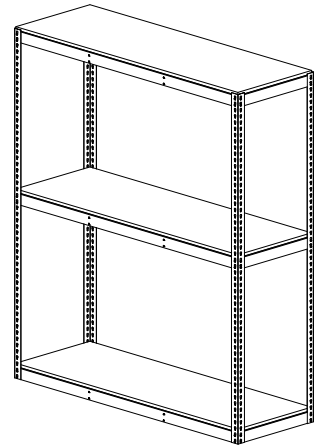

HEAVY DUTY LONG SPAN SHELVING

Without Decking

♦ QUICKSHIP COLORS: Sand and Medium Grey

3 SHELVES (2 OPENINGS)							EXTRA SHELF LEVELS		
CAT. NO.	W	D	H	LOAD CAP.	WT.	PRICE	CAT. NO.	WT.	PRICE
ZL7-4824-3 ♦	48	24	84	2250	65	198.00	ZLES-4824 ♦	13.1	40.00
ZL7-4830-3 ♦	48	30	84	2250	69	210.00	ZLES-4830 ♦	14.4	44.00
ZL7-4836-3 ♦	48	36	84	2250	73	221.00	ZLES-4836 ♦	15.8	47.00
ZL7-4848-3 ♦	48	48	84	2250	82	243.00	ZLES-4848 ♦	18.6	55.00
ZL7-6024-3 ♦	60	24	84	2000	71	217.00	ZLES-6024 ♦	15.1	46.00
ZL7-6030-3 ♦	60	30	84	2000	75	229.00	ZLES-6030 ♦	16.4	50.00
ZL7-6036-3 ♦	60	36	84	2000	79	240.00	ZLES-6036 ♦	17.8	53.00
ZL7-6048-3 ♦	60	48	84	2000	88	262.00	ZLES-6048 ♦	21.0	61.00
ZL7-7224-3 ♦	72	24	84	1750	83	253.00	ZLES-7224 ♦	19.0	58.00
ZL7-7230-3 ♦	72	30	84	1750	88	269.00	ZLES-7230 ♦	21.0	63.00
ZL7-7236-3 ♦	72	36	84	1750	94	282.00	ZLES-7236 ♦	23.0	68.00
ZL7-7248-3 ♦	72	48	84	1750	105	312.00	ZLES-7248 ♦	26.0	78.00
ZL7-9624-3 ♦	96	24	84	1250	100	307.00	ZLES-9624 ♦	25.0	76.00
ZL7-9630-3 ♦	96	30	84	1250	106	327.00	ZLES-9630 ♦	27.0	82.00
ZL7-9636-3 ♦	96	36	84	1250	113	343.00	ZLES-9636 ♦	29.0	88.00
ZL7-9648-3 ♦	96	48	84	1250	127	381.00	ZLES-9648 ♦	34.0	101.00

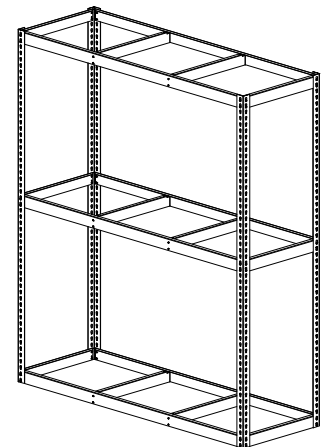

Uses SUR uprights.

Shelves supported on all four sides with wide profile shelf supports (LRA-dd).

1 SDS-dd included with 48" and 60" units; 2 SDS-dd included with 72" units; and 3 SDS-dd included with 96" units.

*Load capacity in pounds per shelf level. Total unit capacity not to exceed 13,000 lbs. per unit (3,250 lbs. per post) based on 24" centers or less.



Look for the red diamond!

tennsco

Systems for Success

Q-LINE SHELVING

Open Style Units, Hinged Door Units

OPEN STYLE UNITS



Starter Unit



Adder Unit

All posts are OAP-87.
All shelves are 22 gauge.
(20 gauge units also available;
call factory for pricing.)

♦ QUICKSHIP COLOR: Medium Grey

UNIT SIZE			LOAD CAP.*	STARTER UNITS			ADDER UNITS		
W	D	H		CAT. NO.	WT.	PRICE	CAT. NO.	WT.	PRICE
5 SHELVES									
36	12	87	750	QO5-3612S♦	62	190.00	QO5-3612A♦	60	182.00
36	18	87	750	QO5-3618S♦	73	220.00	QO5-3618A♦	71	213.00
36	24	87	700	QO5-3624S♦	83	250.00	QO5-3624A♦	81	243.00
48	12	87	500	QO5-4812S♦	73	221.00	QO5-4812A♦	71	214.00
48	18	87	500	QO5-4818S♦	86	256.00	QO5-4818A♦	84	249.00
48	24	87	450	QO5-4824S♦	100	296.00	QO5-4824A♦	98	289.00
6 SHELVES									
36	12	87	750	QO6-3612S♦	69	211.00	QO6-3612A♦	67	204.00
36	18	87	750	QO6-3618S♦	82	248.00	QO6-3618A♦	79	240.00
36	24	87	700	QO6-3624S♦	94	284.00	QO6-3624A♦	92	276.00
48	12	87	500	QO6-4812S♦	82	249.00	QO6-4812A♦	79	242.00
48	18	87	500	QO6-4818S♦	98	291.00	QO6-4818A♦	96	284.00
48	24	87	450	QO6-4824S♦	114	339.00	QO6-4824A♦	112	332.00
8 SHELVES									
36	12	87	750	QO8-3612S♦	83	254.00	QO8-3612A♦	80	247.00
36	18	87	750	QO8-3618S♦	99	303.00	QO8-3618A♦	97	296.00
36	24	87	700	QO8-3624S♦	116	351.00	QO8-3624A♦	114	344.00
48	12	87	500	QO8-4812S♦	99	304.00	QO8-4812A♦	97	297.00
48	18	87	500	QO8-4818S♦	121	360.00	QO8-4818A♦	118	353.00
48	24	87	450	QO8-4824S♦	142	424.00	QO8-4824A♦	140	417.00

HINGED DOOR UNITS, HINGED DOOR & FRAME



Hinged doors come standard with one recessed handle.

♦ QUICKSHIP COLOR: Medium Grey

CAT. NO.	W	D	H	WT.	PRICE
HINGED DOOR UNITS (with 7 openings)					
HDS-8712RH♦	36	12 [§]	87	172	635.00
HDS-8718RH♦	36	18 [§]	87	197	706.00
HDS-8724RH♦	36	24 [§]	87	221	772.00
HINGED DOORS AND FRAMES					
HD-3687RH♦	36	1 1/4*	87	63	299.00
HD-3637RH♦	36	1 1/4*	39	28	216.00

§Depth does not include 1 1/4" depth of door frame or 1/2" depth of handle.

*Depth does not include 1/2" depth of handle.

Q-LINE SHELVING

Closed Style Units, Ledge Unit



CLOSED STYLE ADDER UNITS

◆ QUICKSHIP COLOR: Medium Grey

UNIT SIZE			LOAD CAP.*	STARTER UNITS			ADDER UNITS		
W	D	H		CAT. NO.	WT.	PRICE	CAT. NO.	WT.	PRICE
5 SHELVES									
36	12	87	750	QC5-3612S◆	89	272.00	QC5-3612A◆	83	253.00
36	18	87	750	QC5-3618S◆	107	324.00	QC5-3618A◆	97	294.00
36	24	87	700	QC5-3624S◆	125	372.00	QC5-3624A◆	111	333.00
48	12	87	500	QC5-4812S◆	108	322.00	QC5-4812A◆	102	303.00
48	18	87	500	QC5-4818S◆	129	379.00	QC5-4818A◆	119	349.00
48	24	87	450	QC5-4824S◆	150	437.00	QC5-4824A◆	136	398.00
6 SHELVES									
36	12	87	750	QC6-3612S◆	95	293.00	QC6-3612A◆	89	274.00
36	18	87	750	QC6-3618S◆	116	352.00	QC6-3618A◆	106	322.00
36	24	87	700	QC6-3624S◆	136	406.00	QC6-3624A◆	122	367.00
48	12	87	500	QC6-4812S◆	116	350.00	QC6-4812A◆	110	331.00
48	18	87	500	QC6-4818S◆	141	414.00	QC6-4818A◆	131	384.00
48	24	87	450	QC6-4824S◆	164	480.00	QC6-4824A◆	150	441.00
8 SHELVES									
36	12	87	750	QC8-3612S◆	109	336.00	QC8-3612A◆	103	317.00
36	18	87	750	QC8-3618S◆	134	407.00	QC8-3618A◆	124	377.00
36	24	87	700	QC8-3624S◆	158	473.00	QC8-3624A◆	144	434.00
48	12	87	500	QC8-4812S◆	134	405.00	QC8-4812A◆	128	386.00
48	18	87	500	QC8-4818S◆	163	483.00	QC8-4818A◆	153	453.00
48	24	87	450	QC8-4824S◆	192	565.00	QC8-4824A◆	179	526.00



Starter Unit



Adder Unit

All posts are OAP-87.
All shelves are 22 gauge.
(20 gauge units also available;
call factory for pricing.)

Starter units include two ends and one back panel; adder units include one end and one back panel.

LEDGE UNIT (with 3 openings)

87" Q-Line Unit with Ledge Unit attached.

87" Q-Line Unit with Ledge Unit and Optional Hinged Door and Frame attached.

◆ QUICKSHIP COLOR: Medium Grey

CAT. NO.	W	D	H	WT.	PRICE
LEDGE UNIT					
ILU-3637◆	36	12*	39	45	149.00
HINGED DOOR/FRAME FOR LEDGE UNIT					
HD-3637RH◆	36	1 1/4	39	28	216.00

*Ordering optional hinged door for unit adds 1 1/4" door frame depth and 1/2" handle depth. Hinged door for ledge unit comes standard with one recessed handle.





Look for the red diamond!

tennsco

Systems for Success

Q-LINE SHELVING Shelves

BOX FORM SHELVES (22 GAUGE)

♦ QUICKSHIP COLOR: Medium Grey

CAT. NO.	LOAD CAP.	W	D	H	WT.	PRICE
Q2-3612 ♦	750	36	12	15/16	6.7	22.00
Q2-3615*♦	750	36	15	15/16	7.8	27.00
Q2-3618 ♦	750	36	18	15/16	8.8	28.00
Q2-3624 ♦	700	36	24	15/16	10.9	34.00
Q2-3630*♦	600	36	30	15/16	12.9	44.00
Q2-4212 ♦	600	42	12	15/16	7.7	26.00
Q2-4215*♦	600	42	15	15/16	8.9	33.00
Q2-4218 ♦	600	42	18	15/16	10.1	34.00
Q2-4224 ♦	550	42	24	15/16	12.5	40.00
Q2-4230*♦	500	42	30	15/16	14.8	49.00
Q2-4812 ♦	500	48	12	15/16	8.7	28.00
Q2-4815*♦	500	48	15	15/16	10.1	35.00
Q2-4818 ♦	500	48	18	15/16	11.4	35.00
Q2-4824 ♦	450	48	24	15/16	14.1	43.00
Q2-4830*♦	400	48	30	15/16	16.7	56.00

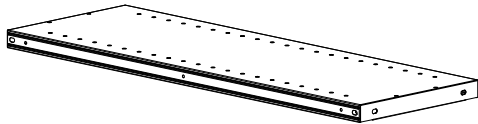

PERFORATED SHELVES (22 GAUGE)

CAT. NO.	LOAD CAP.	W	D	H	WT.	PRICE
PQ2-3612P	450	36	12	15/16	5.8	24.00
PQ2-3615P	450	36	15	15/16	6.7	35.00
PQ2-3618P	450	36	18	15/16	7.5	35.00
PQ2-3624P	400	36	24	15/16	9.2	41.00
PQ2-3630P	350	36	30	15/16	10.8	48.00
PQ2-4215P	375	42	15	15/16	7.6	32.00
PQ2-4224P	325	42	24	15/16	10.5	42.00
PQ2-4230P	275	42	30	15/16	12.9	58.00
PQ2-4812P	300	48	12	15/16	7.4	31.00
PQ2-4815P	300	48	15	15/16	8.5	35.00
PQ2-4818P	300	48	18	15/16	9.6	39.00
PQ2-4824P	250	48	24	15/16	11.7	48.00
PQ2-4830P	200	48	30	15/16	13.9	53.00
PQ2-4836P	175	48	36	15/16	16.2	74.00

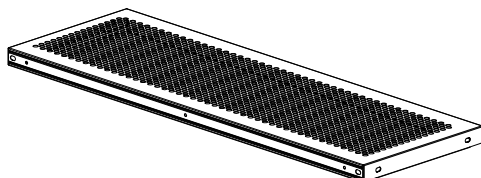

BOX FORM SHELVES (20 GAUGE)

♦ QUICKSHIP COLOR: Medium Grey

CAT. NO.	LOAD CAP.	W	D	H	WT.	PRICE
Q-3612 ♦	1000	36	12	15/16	8.0	25.00
Q-3615*♦	900	36	15	15/16	9.3	31.00
Q-3618 ♦	850	36	18	15/16	10.5	32.00
Q-3624 ♦	800	36	24	15/16	13.0	39.00
Q-3630*♦	800	36	30	15/16	15.4	50.00
Q-3636*♦	600	36	36	15/16	17.9	59.00
Q-4212*	800	42	12	15/16	9.2	30.00
Q-4215	700	42	15	15/16	10.6	37.00
Q-4218 ♦	650	42	18	15/16	12.0	38.00
Q-4224 ♦	650	42	24	15/16	14.9	46.00
Q-4230*	600	42	30	15/16	17.7	56.00
Q-4236*	550	42	36	15/16	21.0	66.00
Q-4812 ♦	650	48	12	15/16	10.4	32.00
Q-4815*	600	48	15	15/16	12.0	41.00
Q-4818 ♦	550	48	18	15/16	13.6	41.00
Q-4824 ♦	550	48	24	15/16	16.8	50.00
Q-4830*	500	48	30	15/16	19.9	62.00
Q-4836*♦	450	48	36	15/16	23.0	73.00

SHELVES WITH STIFFENERS** FOR ADDED WEIGHT CAPACITIES

Q-3624-S*	1000	36	24	15/16	15.4	57.00
Q-3630-S*	1000	36	30	15/16	18.1	68.00
Q-3636-S*	750	36	36	15/16	21.0	78.00
Q-4224-S*	800	42	24	15/16	17.6	64.00
Q-4230-S*	750	42	30	15/16	21.0	75.00
Q-4236-S*	700	42	36	15/16	24.0	86.00
Q-4824-S*	700	48	24	15/16	19.8	72.00
Q-4830-S*	650	48	30	15/16	23.0	82.00
Q-4836-S	600	48	36	15/16	27.0	94.00

**Bin dividers can not be used on shelves with stiffeners.

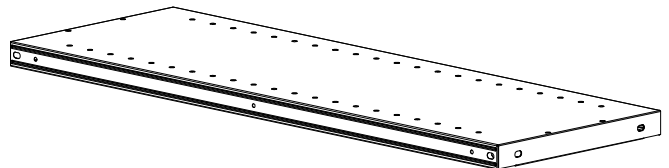

SHELF INFORMATION

(Pertains to all shelves on this page.)

All shelves are Box Beam construction with closed welded corners. Four shelf clips included per shelf (for replacement shelf clips, see page 17).

*For quantities of less than 250 pieces, add \$300/list setup charge.



Q-LINE SHELVING

Posts, Uprights, Shelf Clips, Label Holders



UPRIGHT POSTS

◆ QUICKSHIP COLOR: Medium Grey

CAT. NO.	QTY.	W	D	H	WT.	PRICE
OFFSET ANGLE POST						
OAP-39	12	1	17/8	39	2.4	6.70
OAP-48	12	1	17/8	48	2.9	8.10
OAP-51	12	1	17/8	51	3.1	8.70
OAP-75◆	12	1	17/8	75	4.6	12.50
OAP-84◆	12	1	17/8	84	5.1	13.80
OAP-87◆	12	1	17/8	87	5.3	14.30
OAP-96	12	1	17/8	96	5.9	15.80
OAP-99◆	12	1	17/8	99	6.0	16.30
OAP-111◆	12	1	17/8	111	6.8	18.40
OAP-123◆	12	1	17/8	123	7.5	20.00
BEADED T-POST						
BTP-39	5	3/8	17/8	39	2.7	10.10
BTP-48	5	3/8	17/8	48	3.4	12.30
BTP-51	5	3/8	17/8	51	3.6	13.00
BTP-75◆	5	3/8	17/8	75	5.3	18.10
BTP-84◆	5	3/8	17/8	84	5.9	21.00
BTP-87◆	5	3/8	17/8	87	6.1	21.00
EXTRA HEAVY DUTY BEADED T-POST						
HBP-39	5	3/4	27/8	39	4.4	24.00
HBP-48	5	3/4	27/8	48	5.4	26.00
HBP-51	5	3/4	27/8	51	5.7	30.00
HBP-75	5	3/4	27/8	75	8.4	33.00
HBP-84◆	5	3/4	27/8	84	9.4	35.00
HBP-87◆	5	3/4	27/8	87	9.8	35.00
HBP-99◆	5	3/4	27/8	99	11.1	37.00
HBP-111	5	3/4	27/8	111	12.5	41.00
HBP-123	5	3/4	27/8	123	13.9	45.00

Post slotted for shelf adjustment on 1" centers. Total weight capacity not to exceed 5,000 lbs per unit for OAP and HBP posts. Weight capacity not to exceed 3,500 lbs per unit for BTP posts. Capacities based upon 24" centers or less.

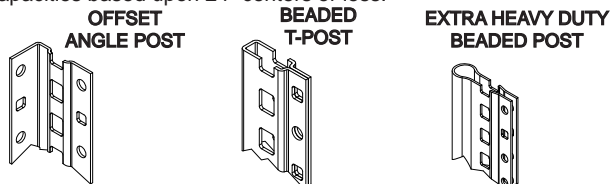

REPLACEMENT SHELF CLIPS

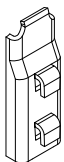

CAT. NO.	W	D	H	WT.	PRICE
T-1	1	1/2	23/4	.1	.44

Attaches shelves to uprights. Shelf clips are Zinc Plated.

WELDED UPRIGHTS

DEPTH	CAT. NO.	H	WT.	PRICE
12" DEEP 	WU-1239	39	7.1	35.00
	WU-1251	51	9.3	41.00
	WU-1275	75	13.7	53.00
	WU-1284	84	15.3	56.00
	WU-1287	87	15.8	59.00
15" DEEP 	WU-1539	39	8.0	37.00
	WU-1551	51	10.5	43.00
	WU-1575	75	15.5	57.00
	WU-1584	84	17.3	62.00
	WU-1587	87	17.9	64.00
18" DEEP 	WU-1839	39	9.1	39.00
	WU-1851	51	11.9	46.00
	WU-1875	75	17.3	62.00
	WU-1884	84	19.6	67.00
	WU-1887	87	20.3	69.00
24" DEEP 	WU-2439	39	10.3	43.00
	WU-2451	51	13.4	52.00
	WU-2475	75	19.7	74.00
	WU-2484	84	22.1	80.00
	WU-2487	87	22.9	82.00
30" DEEP 	WU-3039	39	11.5	49.00
	WU-3051	51	15.1	59.00
	WU-3075	75	22.1	86.00
	WU-3084	84	24.8	93.00
	WU-3087	87	25.7	96.00
36" DEEP 	WU-3639	39	13.0	53.00
	WU-3651	51	17.0	65.00
	WU-3675	75	25.0	95.00
	WU-3684	84	28.0	103.00
	WU-3687	87	29.0	106.00

These are panels attached to OAP style posts. For quantities of less than 50 pieces, add \$100/list setup charge.

LABEL HOLDER

◆ QUICKSHIP COLOR: Medium Grey

CAT. NO.	W	D	H	WT.	PRICE
LH-36◆	36	3/16	7/8	.3	2.90
LH-42	42	3/16	7/8	.4	3.00
LH-48◆	48	3/16	7/8	.5	3.10

Attachment plugs included.

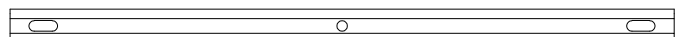



Look for the red diamond!

tennsco

Systems for Success

Q-LINE SHELVING Bin Components, Sway Braces, Sway Plates

BIN DIVIDERS

◆ QUICKSHIP COLOR: Medium Grey

CAT. NO.	W	D	H	WT.	PRICE
12" DEEP					
BD-1206*	7/32	12	6	.6	3.50
BD-1209 ◆	7/32	12	9	1.0	4.30
BD-1212 ◆	7/32	12	12	1.3	7.40
BD-1215*	7/32	12	15	1.6	6.40
BD-1218	7/32	12	18	1.9	6.90
15" DEEP					
BD-1506*	7/32	15	6	1.0	5.20
BD-1509*	7/32	15	9	1.3	6.00
BD-1512*	7/32	15	12	1.8	7.30
BD-1515*	7/32	15	15	2.0	8.70
BD-1518*	7/32	15	18	2.7	9.90
18" DEEP					
BD-1806	7/32	18	6	1.2	5.20
BD-1809	7/32	18	9	1.5	6.00
BD-1812 ◆	7/32	18	12	2.0	7.30
BD-1815	7/32	18	15	2.5	8.70
BD-1818	7/32	18	18	3.0	9.90

*For quantities of less than 250 pieces, add \$300/list setup charge.

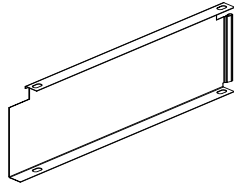

END SWAY BRACES (SOLD IN PAIRS)

◆ QUICKSHIP COLOR: Medium Grey

CAT. NO.	SHELF DEPTH	WT.	PRICE
ESB-1224 ◆	12" to 24"	2.3	7.40
ESB-3036 ◆	30" to 36"	3.0	9.20

Includes hardware.

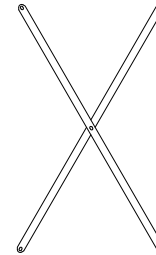

REAR SWAY BRACES (SOLD IN PAIRS)

◆ QUICKSHIP COLOR: Medium Grey

CAT. NO.	UNIT LENGTH	WT.	PRICE
RSBU ◆	36" to 42"	3.1	9.20
RSB-48 ◆	48"	3.6	10.40

Includes hardware. **NOTE:** Use two pairs for uprights 96" and higher, and three pairs for uprights 138" and higher.

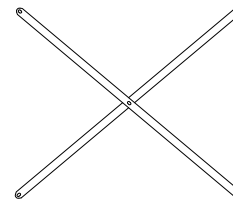

BIN FRONTS

◆ QUICKSHIP COLOR: Medium Grey

CAT. NO.	W	D	H	WT.	PRICE
36" WIDE					
BF-362 ◆	36	3/64	2	1.3	6.80
BF-364	36	3/64	4	2.2	9.40
BF-366	36	3/64	6	2.6	11.60
42" WIDE					
BF-422	42	3/64	2	1.5	7.60
BF-424	42	3/64	4	2.6	10.70
BF-426	42	3/64	6	3.0	14.00
48" WIDE					
BF-482	48	3/64	2	1.7	8.40
BF-484	48	3/64	4	3.0	11.90
BF-486	48	3/64	6	3.5	15.70

Includes hardware.

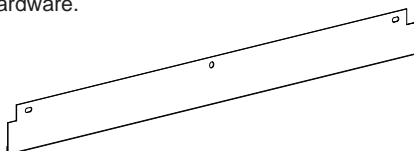

END SWAY PLATES

CAT. NO.	W	D	H	WT.	PRICE
ESP-12	--	12 ⁵ / ₈	5	1.2	10.50
ESP-18	--	18 ⁵ / ₈	5	2.0	13.20
ESP-24	--	24 ⁵ / ₈	5	2.8	19.90

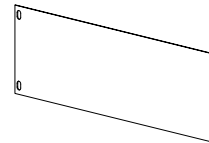

SEISMIC FOOT PLATE

CAT. NO.	W	D	H	WT.	PRICE
IFP-1	3 ¹ / ₄	15 ⁸ / ₈	2 ¹ / ₂	.4	3.70

Order one foot plate for each OAP upright and two foot plates back-to-back for each HBP upright, as shown below.

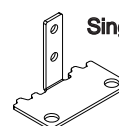

Single Foot Plate for OAP

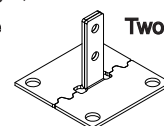

Two Foot Plates for HBP



Q-LINE SHELVING

End/Back Panels, Sliding Dividers, Foot Plates



END PANELS

◆ QUICKSHIP COLOR: Medium Grey

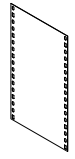
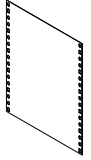
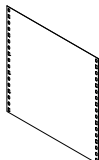
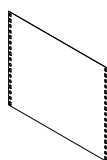
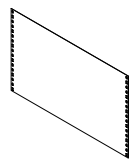
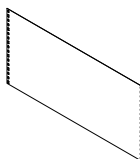
DEPTH	CAT. NO.	HEIGHT	WT.	PRICE
12" DEEP 	EP-1239	39	2.7	10.10
	EP-1248	48	3.3	12.60
	EP-1251◆	51	3.5	13.20
	EP-1275◆	75	5.1	18.10
	EP-1284◆	84	5.7	20.00
	EP-1287◆	87	6.0	19.00
15" DEEP 	EP-1539	39	3.7	13.00
	EP-1548	48	4.5	15.20
	EP-1551◆	51	4.8	15.90
	EP-1575◆	75	7.1	22.00
	EP-1584◆	84	7.9	25.00
	EP-1587◆	87	8.2	25.00
18" DEEP 	EP-1839	39	4.5	15.50
	EP-1848	48	5.5	18.20
	EP-1851◆	51	5.9	19.10
	EP-1875◆	75	8.6	27.00
	EP-1884◆	84	9.6	30.00
	EP-1887◆	87	10.0	30.00
24" DEEP 	EP-2439	39	6.8	20.00
	EP-2448	48	7.5	24.00
	EP-2451◆	51	8.0	24.00
	EP-2475◆	75	11.7	36.00
	EP-2484◆	84	13.1	40.00
	EP-2487◆	87	13.6	39.00
30" DEEP 	EP-3039	39	7.9	25.00
	EP-3048	48	9.7	30.00
	EP-3051	51	10.3	32.00
	EP-3075	75	15.2	46.00
	EP-3084	84	17.0	51.00
	EP-3087	87	17.6	53.00
36" DEEP 	EP-3639	39	9.8	30.00
	EP-3648	48	12.1	36.00
	EP-3651	51	12.9	39.00
	EP-3675	75	18.9	55.00
	EP-3684	84	21.0	62.00
	EP-3687	87	22.0	64.00

BACK PANELS

◆ QUICKSHIP COLOR: Medium Grey

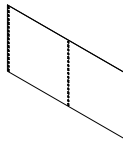
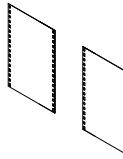
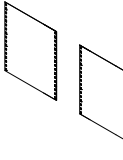
WIDTH	CAT. NO.	HEIGHT	WT.	PRICE
36" WIDE 	BP-3639	39	9.8	33.00
	BP-3648	48	12.1	39.00
	BP-3651◆	51	12.9	41.00
	BP-3675◆	75	18.9	57.00
	BP-3684◆	84	21.0	64.00
	BP-3687◆	87	22.0	68.00
42" WIDE* 	BP-4239	39	11.8	41.00
	BP-4248	48	14.5	48.00
	BP-4251	51	15.4	51.00
	BP-4275	75	23.0	71.00
	BP-4284◆	84	25.0	79.00
	BP-4287◆	87	26.0	82.00
48" WIDE* 	BP-4839	39	14.0	46.00
	BP-4848	48	17.0	54.00
	BP-4851◆	51	18.1	58.00
	BP-4875◆	75	27.0	80.00
	BP-4884◆	84	30.0	89.00
	BP-4887◆	87	31.0	88.00

*42" and 48" backs consist of two pieces. Hardware included.

SLIDING DIVIDERS

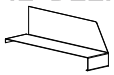
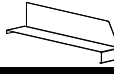
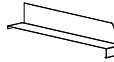
DEPTH	CAT. NO.	H	WT.	PRICE
12" DEEP 	SD-1230	3.0	.7	7.40
	SD-1245	4.5	.9	8.00
	SD-1260	6.0	1.0	8.60
18" DEEP 	SD-1830	3.0	1.1	9.00
	SD-1845	4.5	1.4	9.80
	SD-1860	6.0	1.6	10.60
24" DEEP 	SD-2430	3.0	1.5	10.00
	SD-2445	4.5	1.8	11.00
	SD-2460	6.0	2.0	12.10

FOOT PLATE

◆ QUICKSHIP COLOR: Medium Grey

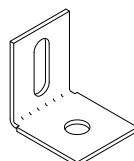

CAT. NO.	W	D	H	WT.	PRICE
FP-1◆	1 1/2	1/16	2 1/4	.1	.68

Used to secure uprights to the floor. **NOTE:** Seismic foot plate is also available; see p.18.



Look for the red diamond!

tennsco

Systems for Success

Q-LINE SHELVING Accessories

SHELF BOXES

CAT. NO.	QTY.	W	D	H	WT.	PRICE
BX-512	12	5 ⁵ / ₈	11	4 ⁹ / ₁₆	2.5	13.10
BX-518	12	5 ⁵ / ₈	17	4 ⁹ / ₁₆	3.3	16.10
BX-812	12	8 ³ / ₈	11	4 ⁹ / ₁₆	3.5	15.90
BX-818	12	8 ³ / ₈	17	4 ⁹ / ₁₆	4.3	18.90
BX-1112	12	11 ¹ / ₄	11	4 ⁹ / ₁₆	4.5	19.50
BX-1118	12	11 ¹ / ₄	17	4 ⁹ / ₁₆	5.3	23.00

One pair of shelf box guides (sold at right) per shelf is recommended. Heights shown are for box front; shelves may be spaced on 6" increments. Comes with one shelf box divider.

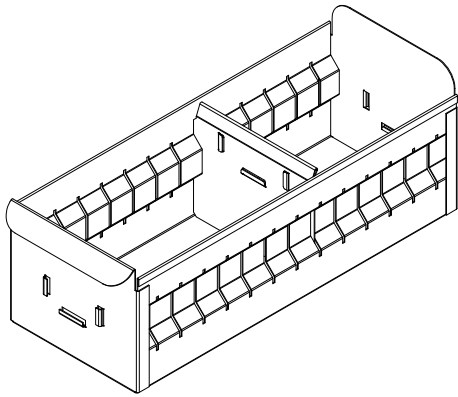

SHELF BOX GUIDES

CAT. NO.	SHELF DEPTH	W	D	H	WT.	PRICE
BXG-12	12	11 ⁷ / ₈	3/4	2 ³ / ₄	.8	9.80
BXG-18	18	17 ⁷ / ₈	3/4	2 ³ / ₄	1.0	10.80

Priced per pair. Includes hardware.

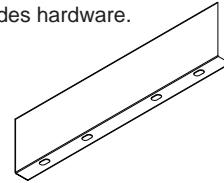

SHELF BOX DIVIDERS (Galvanized)

◆ QUICKSHIP COLOR: Galvanized

CAT. NO.	W	D	H	WT.	PRICE
BXD-5◆	5 ³ / ₁₆	1/32	4 ¹ / ₂	.2	1.00
BXD-8◆	8	1/32	4 ¹ / ₂	.3	1.30
BXD-11◆	10 ⁷ / ₈	1/32	4 ¹ / ₂	.4	1.70

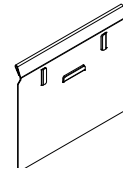

FRONT BASE STRIP

◆ QUICKSHIP COLOR: Medium Grey

CAT. NO.	W	D	H	WT.	PRICE
FBS-362◆	36	1/2	17/8	1.2	7.30
FBS-422◆	42	1/2	17/8	1.5	7.80
FBS-482◆	48	1/2	17/8	1.7	8.40

Attachment screws included.

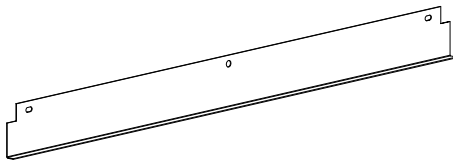

GUSSETS

CAT. NO.	DESCRIPTION	WT.	PRICE
AG-6	CORNER GUSSET (ea.)	.1	2.80
BG-6	BEADED T GUSSET (pr.)	.2	12.50

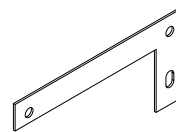

Corner Gusset

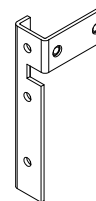

Beaded T-Gussets (1 pair)

MEZZANINE BRACKETS

CAT. NO.	W	D	H	WT.	PRICE
FOR OFFSET ANGLE POST					
MB-3	11/16	2 ¹ / ₄	3	.5	5.10
FOR HEAVY DUTY BEADED POST					
BMB-3	15/32	3 ¹³ / ₁₆	3	.5	4.40

Includes hardware.



MB-3

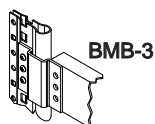

BMB-3

SPLICE PLATES

CAT. NO.	W	D	H	WT.	PRICE
FOR OFFSET ANGLE POST					
SPOA-4	27/32	1 ¹ / ₈	4	.3	4.30
FOR HEAVY DUTY BEADED POST					
SPBT-5	5/8	27/16	5	.5	11.90

Includes hardware.



SPOA-4

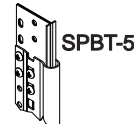

SPBT-5

AUTOMOTIVE SHELVING

Preconfigured Units & Components



AUTOMOTIVE SHELVING UNITS

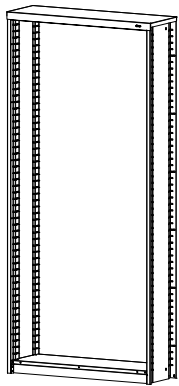

CAT. NO.	W	D	H	WT.	PRICE
P-S84	38	12	84	78	233.00

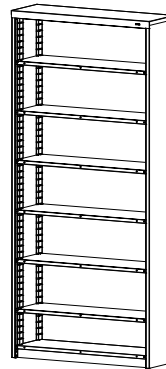

CAT. NO.	W	D	H	WT.	PRICE
P-8401	38	12	84	114	326.00

Unit includes 6 shelves.

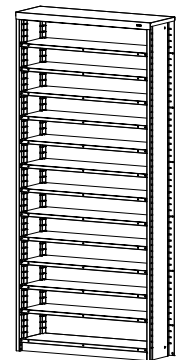

CAT. NO.	W	D	H	WT.	PRICE
P-8417	38	12	84	396	2657.00

Unit includes 108 bin boxes.

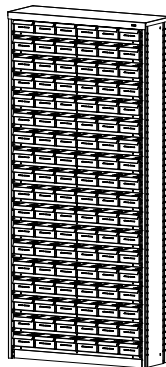

CAT. NO.	W	D	H	WT.	PRICE
P-8411	38	12	84	150	419.00

Unit includes 12 shelves.

Units include back but no end panels. Order end panels separately to provide flush finished ends for row. Dimensions shown are outside dimensions.

UPRIGHTS (Sold In Pairs)

CAT. NO.	W	D	H	WT.	PRICE
P-1242	15/16	12	42	16.0	57.00
P-1284	15/16	12	84	31.8	99.00
P-1296	15/16	12	96	36.0	113.00

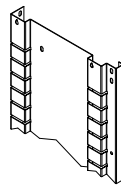

TOPS, BOTTOMS, SHELVES

CAT. NO.	W	D	H	WT.	PRICE
TOP					
P-1238	37 ⁷ / ₈	12 ¹ / ₈	11 ¹ / ₈	6.3	23.00
BOTTOM					
P-12B	36	11 ⁷ / ₈	3 ¹ / ₁₆	7.0	26.00
SHELF					
P-12	35 ⁷ / ₈	11 ⁷ / ₈	7 ⁷ / ₈	6.0	15.50

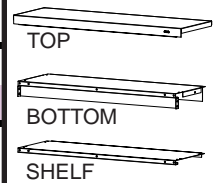

BACKS

CAT. NO.	W	D	H	WT.	PRICE
P-3842	37 ³ / ₄	12	42	17.3	53.00
P-3884	37 ³ / ₄	12	84	32.9	85.00
P-3896	37 ³ / ₄	12	96	37.6	99.00

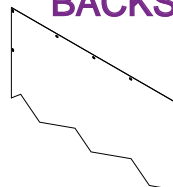

When placing units back to back (as in double-face application), units may share a common back.

END PANELS (Sold In Pairs)

CAT. NO.	W	D	H	WT.	PRICE
P-42E	11/16	12 ³ / ₃₂	42	11	30.00
P-84E	11/16	12 ³ / ₃₂	84	22	59.00
P-96E	11/16	12 ³ / ₃₂	96	25	70.00

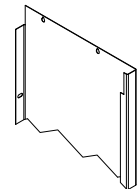

BIN BOXES

CAT. NO.	W	D	H	WT.	PRICE
BIN BOX					
P-55	5 ¹ / ₂	12	3 ¹ / ₄	2.0	20.00
BIN BOX DIVIDER					
P-55D	5 ³ / ₁₆	1 ¹ / ₃₂	2 ⁹ / ₁₆	0.1	1.10

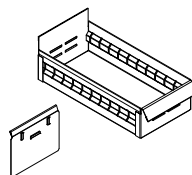

LABEL HOLDERS

CAT. NO.	W	D	H	WT.	PRICE
SHORT WIDTH-USE BETWEEN DIVIDERS					
P-3	3	--	3/4	.02	.68
FULL SHELF-WIDTH					
P-38	33 ¹ / ₄	11 ¹ / ₆₄	7/8	.3	2.70
FASTENER FOR FULL SHELF-WIDTH HOLDERS					
P-38F	--	--	--	.1	.10

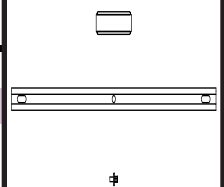

DIVIDERS

CAT. NO.	W	D	H	WT.	PRICE
P-30	3	12	3	.7	6.70
P-45	3	12	4 ¹ / ₂	.9	7.20
P-60	3	12	6	1.0	7.10

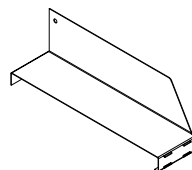



Look for the red diamond!

tennsco

Systems for Success

BULK STORAGE RACK Upright Frames, Spacers, Extensions

UPRIGHT FRAMES (FULLY WELDED CONSTRUCTION)

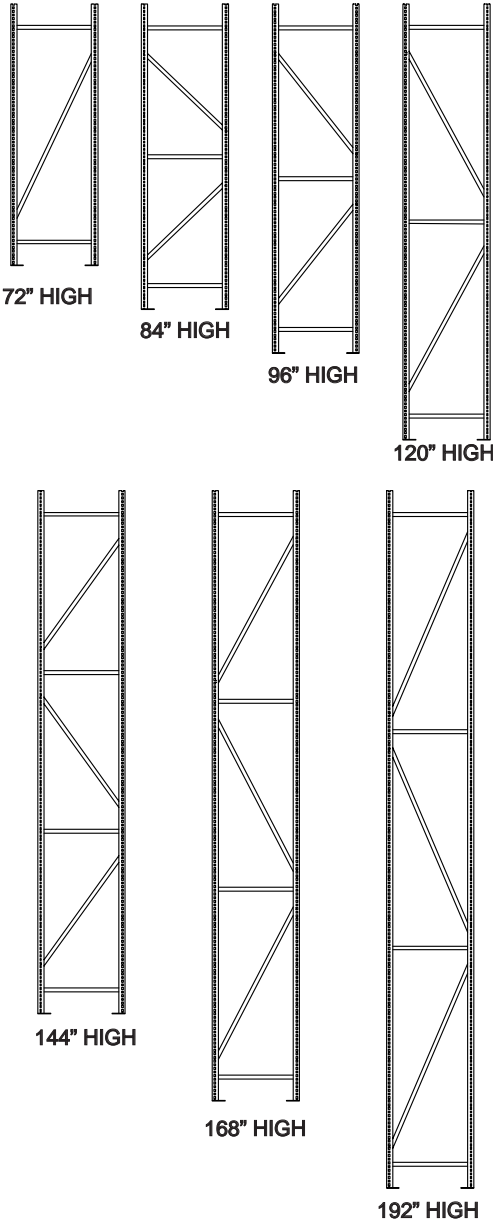

◆ QUICKSHIP COLOR: Medium Grey

CAT. NO.	W	D	H	WT.	PRICE
72" HIGH					
BUF-2472 ◆	13/4	24	72	20	67.00
BUF-3072*	13/4	30	72	21	86.00
BUF-3672 ◆	13/4	36	72	21	72.00
BUF-4272*	13/4	42	72	22	92.00
BUF-4872 ◆	13/4	48	72	23	77.00
84" HIGH					
BUF-2484	13/4	24	84	24	84.00
BUF-3684 ◆	13/4	36	84	25	100.00
BUF-4884	13/4	48	84	27	109.00
96" HIGH					
BUF-2496 ◆	13/4	24	96	28	89.00
BUF-3096*	13/4	30	96	29	96.00
BUF-3696 ◆	13/4	36	96	30	98.00
BUF-4296*	13/4	42	96	32	116.00
BUF-4896 ◆	13/4	48	96	33	108.00
120" HIGH					
BUF-24120 ◆	13/4	24	120	33	108.00
BUF-30120*	13/4	30	120	35	138.00
BUF-36120 ◆	13/4	36	120	36	117.00
BUF-42120*	13/4	42	120	37	147.00
BUF-48120 ◆	13/4	48	120	38	125.00
144" HIGH					
BUF-24144*	13/4	24	144	40	145.00
BUF-36144*	13/4	36	144	43	155.00
BUF-48144*	13/4	48	144	46	162.00
168" HIGH					
BUF-24168*	13/4	24	168	46	183.00
BUF-36168*	13/4	36	168	50	192.00
BUF-48168*	13/4	48	168	53	202.00
192" HIGH					
BUF-24192*	13/4	24	192	53	200.00
BUF-36192*	13/4	36	192	57	203.00

*For quantities of less than 50 uprights, add \$250 list setup charge.
17,000 lb. capacity based on maximum vertical distance of 24" between any two beams on floor.
Other sizes, up to 54d x 192h, are available. Contact factory for pricing.

RACK SPACER

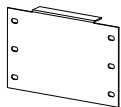

CAT. NO.	W	D	H	WT.	PRICE
BRS-6	8 ²⁹ / ₃₂	1	5 ¹³ / ₁₆	1.0	9.40

Used to attach back-to-back units. Maintains a 6" gap to meet fire codes.

H-FRAME UPRIGHT EXTENSION

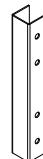

CAT. NO.	W	D	H	WT.	PRICE
SPBUF-10	8 ²⁹ / ₃₂	1 1/2	5 ¹³ / ₁₆	3.3	9.10

Used to splice two bulk frames together for additional height.



BULK STORAGE RACK Components



PLYWOOD BEAM (Sold In Pairs)

♦ QUICKSHIP COLOR: Medium Grey

CAT. NO.	LOAD CAP.	BPS NEEDED (PER LEVEL) TO ACHIEVE LOAD CAPACITY					W	D	H	WT.	PRICE
		24" DEEP	30" DEEP	36" DEEP	42" DEEP	48" DEEP					
BPB-48♦	4150*	2	3	4	6	8	48 ¹ / ₂	11 ¹ / ₂	35 ⁸ / ₈	14.3	42.00
BPB-60♦	3800*	2	2	4	5	6	60 ¹ / ₂	11 ¹ / ₂	35 ⁸ / ₈	17.6	50.00
BPB-72♦	2750*	3	3	3	3	3	72 ¹ / ₂	11 ¹ / ₂	35 ⁸ / ₈	23.0	59.00
BPB-96♦	2150*	4	4	4	4	4	96 ¹ / ₂	11 ¹ / ₂	35 ⁸ / ₈	26.0	75.00

*Capacity calculated for a uniformly distributed load using the recommended number of plywood support angles (BPS-dd), sold below.

Plywood beams are sold as pairs, and are slotted on 6" centers for deck support angles.

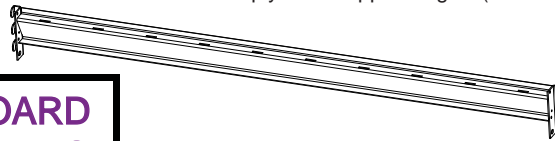

Safety plugs (included) are inserted in each end of the beam to secure posts.

PARTICLEBOARD DECKING (5/8" h)

CAT. NO.	W	D	WT.	PRICE
PB-4824♦	48	24	20	13.50
PB-4830♦	48	30	25	18.70
PB-4836♦	48	36	30	20.00
PB-4842♦	48	42	35	31.00
PB-4848♦	48	48	40	30.00
PB-6024♦	60	24	25	18.70
PB-6030♦	60	30	31.3	24.00
PB-6036♦	60	36	37.5	28.00
PB-6042♦	60	42	43.8	40.00
PB-6048♦	60	48	50	38.00
PB-7224♦	72	24	30	26.00
PB-7230♦	72	30	37.5	28.00
PB-7236♦	72	36	45	34.00
PB-7242♦	72	42	52.5	45.00
PB-7248♦	72	48	60	45.00
PB-9624♦	96	24	40	30.00
PB-9630♦	96	30	50	37.00
PB-9636♦	96	36	60	45.00
PB-9642♦	96	42	70	59.00
PB-9648♦	96	48	80	60.00

Industrial grade 5/8" thick particleboard provides a sturdy work surface that is both strong and economical.



FLAT WIRE DECKING

♦ QUICKSHIP COLOR: Medium Grey

CAT. NO.	W	D	H	WT.	PRICE
ZWD-3624♦	36	24	5/16	8.0	33.00
ZWD-3636♦	36	36	5/16	12.0	49.00
ZWD-4824♦	48	24	5/16	10.7	39.00
ZWD-4836♦	48	36	5/16	16.0	59.00

Wire decking uses 5 gauge wire, & consists of a 2" x 4" mesh pattern. For additional sizes, see page 5.

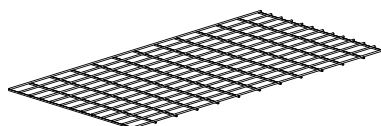

♦ QUICKSHIP COLOR: Medium Grey

CAT. NO.	W	D	H	WT.	PRICE
BPS-24♦	1	24	115/16	1.3	4.10
BPS-30♦	1	30	115/16	1.7	5.70
BPS-36♦	1	36	115/16	2.1	6.00
BPS-42♦	1	42	115/16	2.3	7.50
BPS-48♦	1	48	115/16	2.7	7.80



PLYWOOD SUPPORT ANGLE

See "Plywood Beam" chart (above) for recommended number of BPS-xx to use for various unit widths and depths.

SADDLE CLIP

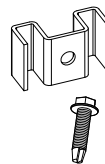

CAT. NO.	W	D	H	WT.	PRICE
SDLC-1	123/32	1	11/16	.1	1.00
TECHSCREWS	--	--	--	.1	.74

Used to hold down bar grating on a mezzanine. Attaches with one tech screw (ordered above).

CORRUGATED DECKING (9/16" h)

♦ QUICKSHIP COLOR: Medium Grey

CAT. NO.	W	D	WT.	PRICE
BSD-4824♦	48	24	14	44.00
BSD-4836♦	48	36	21	61.00
BSD-4848♦	48	48	28	80.00
BSD-6024♦	60	24	17.9	53.00
BSD-6036♦	60	36	26	75.00
BSD-6048♦	60	48	36	97.00
BSD-7224♦	72	24	21	62.00
BSD-7236♦	72	36	31	88.00
BSD-7248♦	72	48	42	115.00
BSD-9624♦	96	24	28	80.00
BSD-9636♦	96	36	40	115.00
BSD-9648♦	96	48	58	151.00

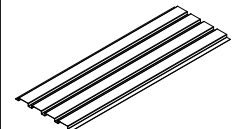

Decking is 9/16" high. Comes in 12" w sections.

BOX BEAM (Sold In Pairs)

CAT. NO.	CAPACITY	W	D	H	WT.	PRICE
BHC-48	2700*	48 ¹ / ₂	1 ¹ / ₂	3	12.5	38.00
BHC-60	2500*	60 ¹ / ₂	1 ¹ / ₂	3	15.0	48.00
BHC-72	1800*	72 ¹ / ₂	1 ¹ / ₂	3	18.1	52.00
BHC-96	1400*	96 ¹ / ₂	1 ¹ / ₂	3	22.0	66.00

*Capacity calculated for uniformly distributed load using recommended number of box beam braces, shown at right.

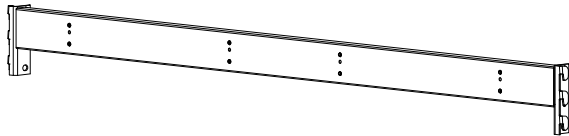

BOX BEAM BRACE

CAT. NO.	W	D	H	WT.	PRICE
SDS-24B	1 ⁵ / ₈	24	2 ⁹ / ₁₆	1.9	5.20
SDS-30B	1 ⁵ / ₈	30	2 ⁹ / ₁₆	2.4	6.50
SDS-36B	1 ⁵ / ₈	36	2 ⁹ / ₁₆	2.8	7.40
SDS-42B	1 ⁵ / ₈	42	2 ⁹ / ₁₆	3.3	9.90
SDS-48B	1 ⁵ / ₈	48	2 ⁹ / ₁₆	3.9	10.10

Use with BHC-ww. Use two SDS-ddB on 48" and 60" beam, three SDS-ddB on 72" beam and four SDS-ddB on 96" beam.

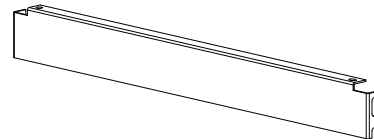

WIRE DECKING

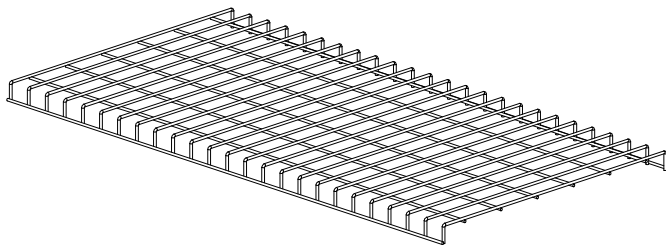

CAT. NO.	W	D	H	WT.	PRICE
BWD-4836	47	36	2 ⁷ / ₃₂	17	74.00
BWD-4848	47	48	2 ⁷ / ₃₂	21.5	87.00

Meets factory mutual codes. 2" x 4" mesh pattern. 2 box beam braces (sold above) required per deck. Other sizes available, Contact factory for details.

Slotted Angle

SLOTTED ANGLE

CAT. NO.	GAUGE	LENGTH	WT.	PRICE
GALVANIZED FINISH				
SA-1410	14	120	7.7	33.00
SA-1412	14	144	9.2	38.00
SA-1210	12	120	10.8	56.00
SA-1212	12	144	12.9	60.00
BAKED-ON ENAMEL FINISH*				
SA-1410P	14	120	7.3	31.00
SA-1412P	14	144	8.8	31.00
SA-1210P	12	120	10.2	44.00
SA-1212P	12	144	12.3	48.00

Packed 5 per bundle. Includes 38 cadmium plated nuts and bolts. Lead times for baked-on enamel finish are longer than for galvanized finish; contact factory for details.

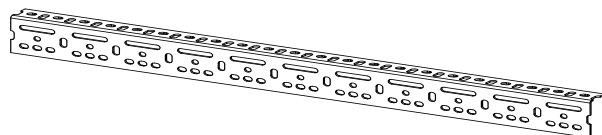

CLEAT AND GUSSET KIT

CAT. NO.	WT.	PRICE
1 KIT WITH 6 CLEATS AND GUSSETS		
CGK-1	9.0	44.00

Cleat and gusset kit contains:
Six 12-gauge galvanized cleats 2¹/₄" x 1¹/₂" x 9" long.
Six 14-gauge galvanized gussets 6" x 6" x 8⁵/₈".

